

# Cisco and Hitachi Adaptive Solutions with SAN Analytics

---

Best Practices Guide

© 2022 Hitachi Vantara LLC. All rights reserved.

No part of this publication may be reproduced or transmitted in any form or by any means, electronic or mechanical, including copying and recording, or stored in a database or retrieval system for commercial purposes without the express written permission of Hitachi, Ltd., or Hitachi Vantara LLC (collectively "Hitachi"). Licensee may make copies of the Materials provided that any such copy is: (i) created as an essential step in utilization of the Software as licensed and is used in no other manner; or (ii) used for archival purposes. Licensee may not make any other copies of the Materials. "Materials" mean text, data, photographs, graphics, audio, video and documents.

Hitachi reserves the right to make changes to this Material at any time without notice and assumes no responsibility for its use. The Materials contain the most current information available at the time of publication.

Some of the features described in the Materials might not be currently available. Refer to the most recent product announcement for information about feature and product availability, or contact Hitachi Vantara LLC at [https://support.hitachivantara.com/en\\_us/contact-us.html](https://support.hitachivantara.com/en_us/contact-us.html).

**Notice:** Hitachi products and services can be ordered only under the terms and conditions of the applicable Hitachi agreements. The use of Hitachi products is governed by the terms of your agreements with Hitachi Vantara LLC.

By using this software, you agree that you are responsible for:

1. Acquiring the relevant consents as may be required under local privacy laws or otherwise from authorized employees and other individuals; and
2. Verifying that your data continues to be held, retrieved, deleted, or otherwise processed in accordance with relevant laws.

**Notice on Export Controls.** The technical data and technology inherent in this Document may be subject to U.S. export control laws, including the U.S. Export Administration Act and its associated regulations, and may be subject to export or import regulations in other countries. Reader agrees to comply strictly with all such regulations and acknowledges that Reader has the responsibility to obtain licenses to export, re-export, or import the Document and any Compliant Products.

Hitachi and Lumada are trademarks or registered trademarks of Hitachi, Ltd., in the United States and other countries.

AIX, AS/400e, DB2, Domino, DS6000, DS8000, Enterprise Storage Server, eServer, FICON, FlashCopy, GDPS, HyperSwap, IBM, Lotus, MVS, OS/390, PowerHA, PowerPC, RS/6000, S/390, System z9, System z10, Tivoli, z/OS, z9, z10, z13, z14, z/VM, and z/VSE are registered trademarks or trademarks of International Business Machines Corporation.

Active Directory, ActiveX, Bing, Excel, Hyper-V, Internet Explorer, the Internet Explorer logo, Microsoft, Microsoft Edge, the Microsoft corporate logo, the Microsoft Edge logo, MS-DOS, Outlook, PowerPoint, SharePoint, Silverlight, SmartScreen, SQL Server, Visual Basic, Visual C++, Visual Studio, Windows, the Windows logo, Windows Azure, Windows PowerShell, Windows Server, the Windows start button, and Windows Vista are registered trademarks or trademarks of Microsoft Corporation. Microsoft product screen shots are reprinted with permission from Microsoft Corporation.

All other trademarks, service marks, and company names in this document or website are properties of their respective owners.

Copyright and license information for third-party and open source software used in Hitachi Vantara products can be found in the product documentation, at <https://www.hitachivantara.com/en-us/company/legal.html> or [https://knowledge.hitachivantara.com/Documents/Open\\_Source\\_Software](https://knowledge.hitachivantara.com/Documents/Open_Source_Software).

## Feedback

Hitachi Vantara welcomes your feedback. Please share your thoughts by sending an email message to [SolutionLab@HitachiVantara.com](mailto:SolutionLab@HitachiVantara.com). To assist the routing of this message, use the paper number in the subject and the title of this white paper in the text.

## Revision history

Changes	Date
Updated image quality	September 22, 2022
Initial release	August 1, 2022

---

# Best Practices Guide

This guide documents the best practices of using SAN Analytics software to identify, resolve, and troubleshoot performance degradation of a Cisco UCS fabric backed by a Hitachi Virtual Storage Platform. The solution uses the Fibre Channel-Non-Volatile Memory Express (NVMe) protocol to back a VMware 7.0U3 virtualized environment. This document does not cover configuration.

This guide is written for professional services staff such as storage administrators, VMware administrators, sales engineers, field consultants, and validated Hitachi and Cisco resale partners. Readers of this document must have knowledge of RAID systems and functionality, VMware ESXi and vCenter environments, and converged infrastructure.



**Note:** Testing of these procedures was in a lab environment. Many factors impact production environments beyond prediction or duplication in a lab environment. Follow the recommended practice of conducting proof-of-concept testing in a non-production, isolated test environment that otherwise matches your production environment before your production implementation of this solution.

## Introduction

Fibre Channel is a high-speed data transfer protocol that provides in-order lossless delivery of raw block data. It is designed to provide connections between endpoint servers and storage devices. This technology supports point-to-point devices through a common fabric known as a Storage Area Network (SAN). Fibre Channel SANs are typically deployed for low latency applications that are best suited to block-based storage, such as databases used for high-speed online transactional processing (OLTP) and those found in banking, online ticketing, and virtual environments.

Because Fibre Channel SANs are lossless, end users often find themselves in situations of SAN congestion caused by overutilization of an edge link or a slow drain device. Although both scenarios have the same results, the reasons are different. Congestion caused by overutilization of an edge-link happens when the switch receives more traffic than can be sent on the link. In contrast, congestion caused by a slow drain happens when a device cannot process the frames as fast as its ingress rate because of issues such as high CPU usage or even a software defect. In turn, this device, called a slow drain device, applies backpressure by slowing down Receiver Ready (R\_RDY) signals.

## SAN configuration

This is a best-practice datacenter architecture built by Hitachi Vantara and Cisco Systems to meet your enterprise needs using virtual server workloads. It uses a Hitachi Virtual Storage Platform (VSP) storage system to connect the Cisco MDS Multilayer switches that control Fibre Channel/SAN communication to the Cisco UCS Fabric Interconnects and Cisco UCS chassis.

Northbound Ethernet/LAN networking is enabled through the Cisco Nexus 9000 family of switches. For information about SAN connectivity and network connectivity see the [Cisco and Hitachi Adaptive Solutions for Converged Infrastructure Deployment Guide](#).

The following figure shows the validated architecture for Cisco and Hitachi Adaptive Solutions for Converged Infrastructure. Red lines represent Fabric A connections, blue lines represent Fabric B connections, and the rest are port channel connections.

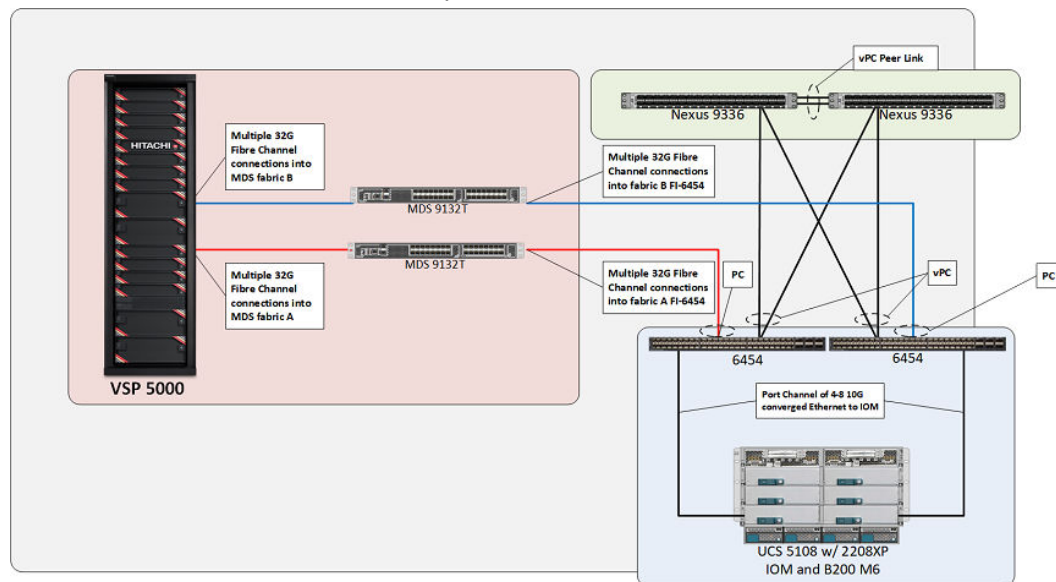

## Solution components

The following tables list the tested solution components.

**Table 1 Hardware components**

Component	Version
Hitachi Virtual Storage Platform VSP 5600H	90-07-01-00/00
Cisco MDS 9132T Fibre Channel switch	MDS NX-OS 9.2(2)
Cisco Nexus 9332-FX2 switch	NX-OS 7.0(3)I7(9)
Cisco Fabric Interconnect 6454	4.2(1i)
Cisco Unified Computing System B200 M6 Blade Servers	4.2(1i)
Cisco Unified Computing System 2208XP IOM	4.2(1i)

**Table 2 Software components**

Component	Version
VMware vCenter Standalone (VCSA) 7.0 U3	7.0.3, 19234570
VMware ESXi 7.0 U3 Cisco Custom Image	7.0.3, 19193900
VMware ESXi 7.0U3 nenic	1.0.42.0
VMware ESXi 7.0U3 nfnic	5.0.0.34
Hitachi Ops Center Analyzer	10.8.1
Cisco Nexus Dashboard Fabric Controller	12.0.1a

## Overutilization

Overutilization was purposely created within the Cisco UCS environment backed by Hitachi VSP storage to explore the software capabilities of Hitachi Ops Center Analyzer and Cisco SAN Analytics in conjunction with Cisco Nexus Dashboard Fabric Controller (NDFC). With overutilization, the data transfer rate (Tx Data rate) from the storage system is faster than the host port speed. Tx Data rate is the transmitted data rate respective to the port.

A Tx Data rate mismatch can be caused by an 8G link or port-channel that is connected to a server and a storage system that is backed by a 32G link which causes a speed mismatch where the incoming data is more than what can be sent by the 8G link. This requires the switch to buffer the data until it can be processed, which causes backpressure to occur directly on the Cisco MDS switch, where R\_RDY signals are sent slowly because of a lack of free receiver buffers.

The host that is connected to an over-utilized link might not be impacted, but other servers on the fabric are impacted because of backpressure congestion. The following figure represents the Cisco UCS during overutilization conditions. The red arrows depicted on the storage ports represent SAN congestion.

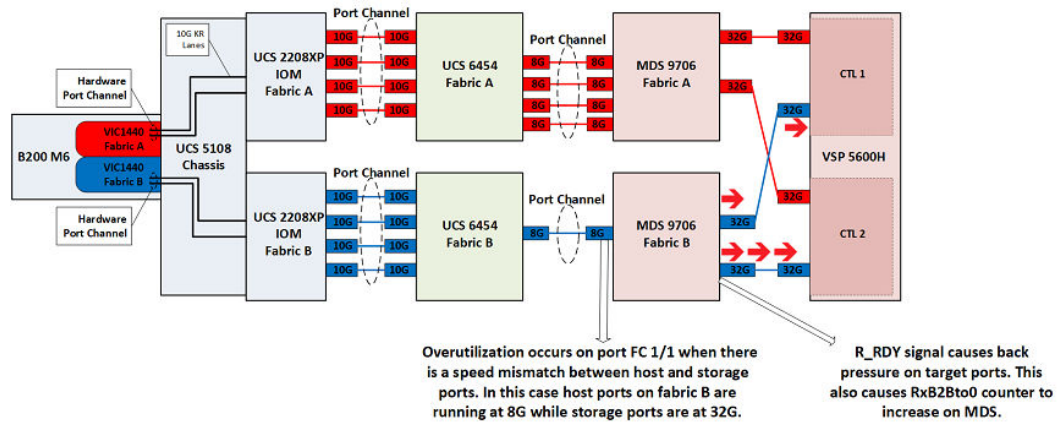

## Hitachi Ops Center Analyzer

Hitachi Ops Center Analyzer allows end-to-end metric collection from compute hosts, Fibre Channel switches, and backend storage systems. The best practices in this guide cover configuration and installation instructions as well as how to use Hitachi Ops Center Analyzer features to detect, troubleshoot, and resolve performance degradation within a Cisco UCS SAN fabric backed by Hitachi VSP storage. The following figure shows Ops Center Analyzer capabilities.

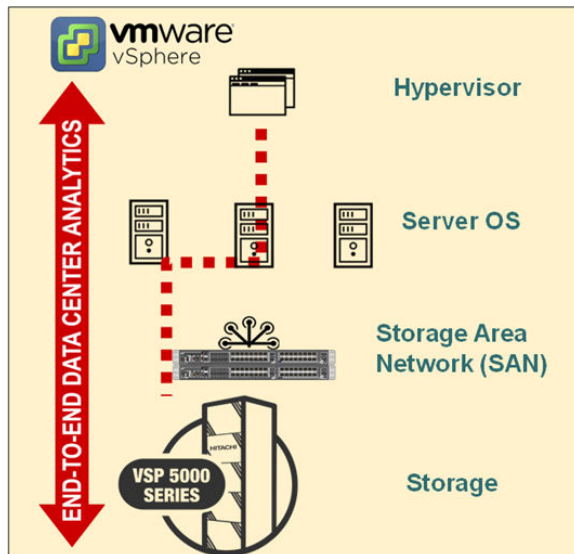

## Cisco SAN Analytics and Cisco Nexus Dashboard Fabric Controller

The Cisco SAN Analytics solution offers end-to-end visibility into Fibre Channel block storage traffic. The solution is natively available on the storage area network because of the integrated-by-design architecture with the Cisco MDS 9000 switch family.

Cisco SAN Analytics delivers deep visibility into I/O traffic between the compute and the storage infrastructure. This information is in addition to the already-available visibility obtained from individual ports, switches, servers, virtual machines, and storage systems. Cisco MDS switches export all the metrics to Cisco Nexus Dashboard Fabric Controller (NDFC) using streaming telemetry. In turn, NDFC automatically calculates performance baselines and categorizes the devices based on their deviations. It also provides alerting using the Anomaly Detection feature.

Cisco SAN Analytics and NDFC can be used to detect, troubleshoot, and resolve performance degradation within a Cisco UCS SAN fabric backed by Hitachi VSP storage. The following figure shows the NDFC capabilities.

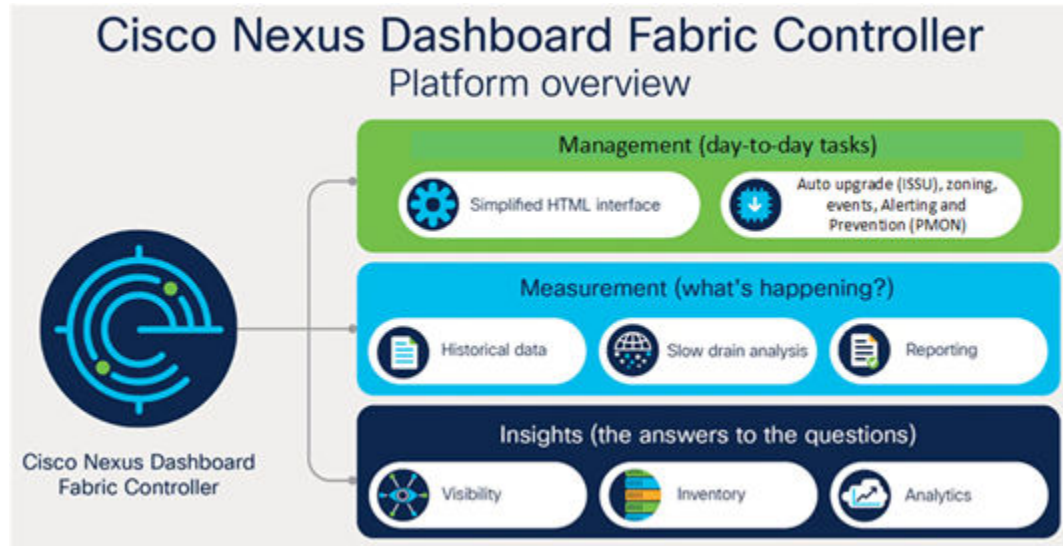

## Cisco SAN Analytics and NDFC best practices

This section describes how to identify, troubleshoot, and resolve performance and congestion issues using Cisco SAN Analytics and NDFC.

### Cisco MDS

This section describes Cisco MDS NX-OS commands.

#### Tx and Rx detection

Using the Cisco NX-OS CLI on Cisco MDS switches, administrators can run simple commands to obtain insight into counters and credits available for ports being used as targets within the fabric. In the following examples, Fibre Channel ports 1/19 and 1/20 on Fabric B are the target ports. The following command displays the ports that are used through counters as well as the remaining B2B credits:

```
show interface counters brief
```



This command helps administrators understand link utilization. The following figure shows that fc1/1, fc1/19, and fc1/20 are experiencing high I/O rate and frame count. The port-channel between Cisco MDS and Fabric Interconnect is on fc1/1. The output rate on fc1/1 is approximately 800 Mbps, which is the maximum data-rate of an 8G Fibre Channel port. This condition indicates congestion because of the overutilization of fc1/1.

```
U34-C9132T-B# show interface counters brief
```

Interface	Input (rate is 5 min avg)		Output (rate is 5 min avg)	
	Rate MB/s	Total Frames	Rate MB/s	Total Frames
fc1/1	114	51315550158	837	169617631977
fc1/2	0	11390963742	0	38120762559
fc1/3	0	11428954428	0	38089393381
fc1/4	0	11273758059	0	38079427577
fc1/5	0	10206676	0	2018604
fc1/6	0	9841071	0	2012764
fc1/7	0	9485144	0	2019418
fc1/8	0	10011823	0	2016445
fc1/9	0	1	0	1
fc1/10	0	1	0	1
fc1/11	0	1	0	1
fc1/12	0	1	0	1
fc1/13	0	1	0	1
fc1/14	0	1	0	1
fc1/15	0	1	0	1
fc1/16	0	1	0	1
fc1/17	0	1	0	1
fc1/18	0	1	0	1
fc1/19	410	127426181231	48	27644280731
fc1/20	410	127469771392	48	27654064457
fc1/21	2	1757071402	5	2359439125
fc1/22	2	1757211510	6	2349556301
fc1/23	2	6353550476	1	6353550478
fc1/24	2	6360759917	1	6360759918
fc1/25	2	6482283544	1	6482283545
fc1/26	2	6051728364	0	6051728365
fc1/27	0	62528759	0	50651785
fc1/28	0	81025015	0	57484264
fc1/29	0	60969968	0	26699624
fc1/30	0	44186262	0	18749962
fc1/31	0	4038759	0	19763036
fc1/32	0	4026983	0	19780205
port-channel12	114	85409242160	837	283907264563
port-channel20	0	39544714	0	8067231

## RxB2Bto0 counters

Use the following command to obtain additional interface details:

```
show interface <fc-port> counters
```



This command helps administrators understand how many buffer credits remain on a per-port basis. A receive B2B credits value of 0 indicates that the port is under congestion conditions. The receive B2B credits remaining shown in the following figure is an instantaneous value. Therefore, the quickly incrementing value of a receive B2B credit that transitions to zero is an important metric.

```

U34-C9132T-B# show interface fcl/20 counters
fcl/20
 5 minutes input rate 3282892960 bits/sec, 410361620 bytes/sec, 225787 frames/sec
 5 minutes output rate 387942208 bits/sec, 48492776 bytes/sec, 48679 frames/sec
127507189942 frames input, 230605689492868 bytes
 0 class-2 frames, 0 bytes
127507189891 class-3 frames, 230605689492868 bytes
 0 class-f frames, 0 bytes
 0 discards, 0 errors, 0 CRC/FCS
 0 unknown class, 0 too long, 0 too short
27662140138 frames output, 27440156566672 bytes
 0 class-2 frames, 0 bytes
27662140133 class-3 frames, 27440156566672 bytes
 0 class-f frames, 0 bytes
 0 discards, 0 errors
 0 Zone drops
 0 FIB drops for ports 17-32
 0 XBAR errors for ports 17-32
 0 Other drop count for ports 20-20
 0 timeout discards, 0 credit loss
 1 input OLS, 1 LRR, 0 NOS, 0 loop inits
 1 output OLS, 0 LRR, 0 NOS, 0 loop inits
 0 link failures, 0 sync losses, 0 signal losses
3242917 Transmit B2B credit transitions to zero
10135977008 Receive B2B credit transitions to zero
459358 2.5us TxWait due to lack of transmit credits
Percentage TxWait for last 1s/1m/1h/72h: 0%/0%/0%/0%
0 receive B2B credit remaining
12 transmit B2B credit remaining
12 low priority transmit B2B credit remaining
Last clearing of "show interface" counters: never

```

## Port Monitor logging

Port Monitor is a feature of Cisco MDS 9000 switches that monitors data-plane metrics at a low granularity (such as 1 second) and takes automatic actions, such as generating alerts, shutting down a port, isolating a port, or enabling Dynamic Ingress Rate Limiting.

A Port Monitor policy must be configured using the NX-OS CLI or NDFC. When configured thresholds are exceeded, alerts can be sent to remote syslog servers or SNMP trap receivers. The switch stores these alerts in the form of logs. The following output shows the thresholds of various metrics set using Port Monitor.

```
U34-C9132T-B# show port-monitor active
DIRL :
Recovery Interval : 60 seconds

-----
Policy Name : Normal edgePort
Admin status : Active
Oper status : Active
Port type : All Edge Ports
-----
```

Counter	Threshold Type	Interval (Secs)	Warning		Thresholds		Rising/Falling actions			Congestion-signal	
			Threshold	Alerts	Rising	Falling	Event	Alerts	PortGuard	Warning	Alarm
Link Loss	Delta	60	none	n/a	5	1	4	syslog,immon	none	n/a	n/a
Sync Loss	Delta	60	none	n/a	5	1	4	syslog,immon	none	n/a	n/a
Signal Loss	Delta	60	none	n/a	5	1	4	syslog,immon	none	n/a	n/a
Invalid Words	Delta	60	none	n/a	5	1	4	syslog,immon	none	n/a	n/a
Invalid CRC's	Delta	60	none	n/a	5	1	4	syslog,immon	none	n/a	n/a
State Change	Delta	60	none	n/a	5	0	4	syslog,immon	none	n/a	n/a
TX Discards	Delta	60	none	n/a	50	0	4	syslog,immon	none	n/a	n/a
LR RX	Delta	60	none	n/a	5	1	4	syslog,immon	none	n/a	n/a
LR TX	Delta	60	none	n/a	5	1	4	syslog,immon	none	n/a	n/a
Timeout Discards	Delta	60	none	n/a	200	10	4	syslog,immon	none	n/a	n/a
Credit Loss Recp	Delta	1	none	n/a	2	0	4	syslog,immon	none	n/a	n/a
TX Credit Not Available	Delta	1	none	n/a	10%	0%	4	syslog,immon	obfl	n/a	n/a
RX Datarate	Delta	60	none	n/a	80%	70%	4	syslog,immon,obfl	none	n/a	n/a
TX Datarate	Delta	10	none	n/a	80%	75%	4	syslog,immon,obfl	DIRL	n/a	n/a
ASIC Error Pkt from Port	Delta	60	none	n/a	50	10	4	syslog,immon	none	n/a	n/a
ASIC Error Pkt to xbar	Delta	60	none	n/a	50	10	4	syslog,immon	none	n/a	n/a
ASIC Error Pkt from xbar	Delta	60	none	n/a	50	10	4	syslog,immon	none	n/a	n/a
TX-slowport-Oper-Delay	Absolute	1	none	n/a	50ms	0ms	4	syslog,immon	none	n/a	n/a
TXWait	Delta	1	none	n/a	40%	0%	4	syslog,immon	none	n/a	n/a
SFP TX Power Low Warning	Delta	600	none	n/a	1890%	0890%	4	syslog,immon	none	n/a	n/a
SFP RX Power Low Warning	Delta	600	none	n/a	1890%	0890%	4	syslog,immon	none	n/a	n/a
RX Datarate Burst	Delta	60	none	n/a	5890%	1890%	4	syslog,immon,obfl	none	n/a	n/a
TX Datarate Burst	Delta	60	none	n/a	5890%	1890%	4	syslog,immon,obfl	none	n/a	n/a
Input Errors	Delta	60	none	n/a	5	1	4	syslog,immon	none	n/a	n/a

Run the following command to view logs based on port monitor thresholds:

```
show log | grep fc<interface number>
```

The output of this command shows alerts that have been triggered according to port monitoring policies. The following figure represents fc1/1 showing a Tx Datarate Burst reaching a rising threshold of 5 times at 90% utilization at a polling interval of 60 seconds. The Tx Datarate Burst identifies an interface that faces the maximum data transmission for which the port is capable.

```
U34-C9132T-B# show log | grep port=fc1/1
2022 Feb 16 18:38:57 U34-C9132T-B 4#MON-SLOT1-4-RISING_THRESHOLD_REACHED_WARNING: TX Datarate Burst has reached the rising threshold (port=fc1/1 [0x10000000], value=5) .
2022 Feb 16 18:39:41 U34-C9132T-B 4#MON-SLOT1-4-RISING_THRESHOLD_REACHED_WARNING: TX Datarate has reached the rising threshold (port=fc1/1 [0x10000001], value=51099658825) .
```

## Overutilization congestion prevention using Cisco MDS Dynamic Ingress Rate Limiting

Cisco MDS Dynamic Ingress Rate Limiting (DIRL) identifies and resolves SAN congestion. DIRL must be enabled from Port Monitor to detect any symptoms of egress congestion on the switch ports. Then DIRL limits ingress data to prevent congestion in the egress direction. DIRL dynamically adapts the ingress traffic rate until the egress congestion is gone. By limiting ingress frames, DIRL also slows down the data-requesting frames (read I/O command) to the storage system.

To view DIRL settings on a fabric using MDS NX-OS, run the following command:

```
show port-monitor active
```

```

U34-C9132T-B# show port-monitor active
DIRL :
  Recovery Interval : 60 seconds
-----
Policy Name : Normal_edgePort
Admin status : Active
Oper status : Active
Port type : All Edge Ports
-----

```

Counter	Threshold Type	Interval (Secs)	Warning		Thresholds			Rising/Falling actions	
			Threshold	Alerts	Rising	Falling	Event	Alerts	PortGuard
Link Loss	Delta	60	none	n/a	5	1	4	syslog,rmon	none
Sync Loss	Delta	60	none	n/a	5	1	4	syslog,rmon	none
Signal Loss	Delta	60	none	n/a	5	1	4	syslog,rmon	none
Invalid Words	Delta	60	none	n/a	5	1	4	syslog,rmon	none
Invalid CRC's	Delta	60	none	n/a	5	1	4	syslog,rmon	none
State Change	Delta	60	none	n/a	5	0	4	syslog,rmon	none
TX Discards	Delta	60	none	n/a	50	0	4	syslog,rmon	none
IR RX	Delta	60	none	n/a	5	1	4	syslog,rmon	none
IR TX	Delta	60	none	n/a	5	1	4	syslog,rmon	none
Timeout Discards	Delta	60	none	n/a	200	10	4	syslog,rmon	none
Credit Loss Reco	Delta	1	none	n/a	1	0	4	syslog,rmon	none
TX Credit Not Available	Delta	1	none	n/a	10%	0%	4	syslog,rmon	none
RX Datarate	Delta	60	none	n/a	80%	70%	4	syslog,rmon,obfl	none
TX Datarate	Delta	10	none	n/a	80%	70%	4	syslog,rmon,obfl	DIRL
ASIC Error Pkt from Port	Delta	60	none	n/a	50	10	4	syslog,rmon	none
ASIC Error Pkt to xbar	Delta	60	none	n/a	50	10	4	syslog,rmon	none
ASIC Error Pkt from xbar	Delta	60	none	n/a	50	10	4	syslog,rmon	none
TX-Slowport-Oper-Delay	Absolute	1	none	n/a	50ms	0ms	4	syslog,rmon	none
TXWait	Delta	1	none	n/a	40%	0%	4	syslog,rmon	none
SFP TX Power Low Warning	Delta	600	none	n/a	1890%	0890%	4	syslog,rmon	none
SFP RX Power Low Warning	Delta	600	none	n/a	1890%	0890%	4	syslog,rmon	none
RX Datarate Burst	Delta	60	none	n/a	5890%	1890%	4	syslog,rmon,obfl	none
TX Datarate Burst	Delta	60	none	n/a	5890%	1890%	4	syslog,rmon,obfl	none
Input Errors	Delta	60	none	n/a	5	1	4	syslog,rmon	none

This command output shows that the Tx Data rate port guard DIRL has been set to prevent congestion among both slow and fast devices within the same fabric. Additionally, to view alerts for DIRL prevention, you can use the following command:

```
show logging last 20
```

```

U34-C9132T-B #MON-SLOT1-3-FLOW PORTGUARD ACTION: PortGuard Config (DIRL) recovery action sent to FPM for Port fcl/1(1000000) Counter Tx-datarate
U34-C9132T-B #MON-SLOT1-4-RISING THRESHOLD REACHED WARNING: TX Datarate has reached the rising threshold (port=fcl/1 (1000000), value=1334132)
U34-C9132T-B #MON-SLOT1-4-FLOW PORTGUARD ACTION: PortGuard Config (DIRL) rate-limit action sent to FPM for Port fcl/1(1000000) Counter Tx-datarate
U34-C9132T-B #MON-SLOT1-4-FALLING THRESHOLD REACHED WARNING: TX Datarate has reached the falling threshold (port=fcl/1 (1000000), value=77317)
U34-C9132T-B #MON-SLOT1-3-FLOW PORTGUARD ACTION: PortGuard Config (DIRL) recovery action sent to FPM for Port fcl/1(1000000) Counter Tx-datarate
U34-C9132T-B #MON-SLOT1-3-FLOW PORTGUARD ACTION: PortGuard Config (DIRL) recovery action sent to FPM for Port fcl/1(1000000) Counter Tx-datarate

```

This command output shows DIRL action that prevents fc/1 TxData rate so that overutilization does not occur.

## Per-flow traffic utilization on a switch port in real-time

Real-time performance statistics are a useful tool in dynamic troubleshooting and fault isolation within the fabric. For any port on a switch, you can monitor several statistics with granular intervals that can consist of the top 10 metrics for initiator, target, and LUN (ITL) flows and initiator, target, and Namespace (ITN) flows. SAN Analytics must be enabled for this feature.

Run the following command to display per-flow traffic utilization with the highest throughput.



**Note:** Additional metrics aside from throughput, such as an I/O per second (IOPS) and Exchange Completion Time (ECT), are also available.

```
show analytics -top -key THPUT
```

The output of this command shows the top 10 ITL flows with the highest throughput in correlation with the initiator, target, and VSP LUN. This command updates the display every 3-4 seconds. It finds the top 10 flows among tens of thousands of flows that might be active on the switch.

```
U34-C9132T-B# showanalytics --top --key THPUT
Data collected at : Wed, 23 Feb 2022 23:03:56 -0000
+-----+-----+-----+-----+-----+-----+-----+
| PORT | VSAN | Initiator | Target | LUN | Avg Throughput |
+-----+-----+-----+-----+-----+-----+-----+
|      |      |           |        |     | Read | Write |
+-----+-----+-----+-----+-----+-----+-----+
| fc1/22 | 102 | 0x190044 | 0x190160 | 0000-0000-0000-0000 | 339.0 KB/s | 1.3 MB/s |
| fc1/21 | 102 | 0x190042 | 0x190180 | 0000-0000-0000-0000 | 829.0 KB/s | 711.6 KB/s |
| fc1/21 | 102 | 0x190043 | 0x190180 | 0018-0000-0000-0000 | 43.0 KB/s | 1.3 MB/s |
| fc1/21 | 102 | 0x190043 | 0x190180 | 0019-0000-0000-0000 | 728.8 KB/s | 513.0 KB/s |
| fc1/27 | 102 | 0x190043 | 0x1900a1 | 001c-0000-0000-0000 | 672.8 KB/s | 449.0 KB/s |
| fc1/28 | 102 | 0x190042 | 0x1900c1 | 001c-0000-0000-0000 | 315.1 KB/s | 513.0 KB/s |
| fc1/22 | 102 | 0x190042 | 0x190160 | 0000-0000-0000-0000 | 508.0 KB/s | 298.0 KB/s |
| fc1/22 | 102 | 0x190041 | 0x190160 | 0000-0000-0000-0000 | 370.0 KB/s | 227.0 KB/s |
| fc1/22 | 102 | 0x190044 | 0x190160 | 0013-0000-0000-0000 | 0 B/s | 424.8 KB/s |
| fc1/21 | 102 | 0x190041 | 0x190180 | 0000-0000-0000-0000 | 199.0 KB/s | 92.0 KB/s |
+-----+-----+-----+-----+-----+-----+-----+
```

Use the following command output to retrieve additional performance information to investigate SAN performance statistics of the initiator, target, and LUN. The following command drills down into initiator 0x190043, target 0x190160 and LUN 18:

```
showanalytics --initiator 0x190043 --target 0x190160 --lun 0018-0000-0000-0000 --info --target-itl
```

```
U34-C9132T-B# showanalytics --initiator 0x190043 --target 0x190160 --lun 0018-0000-0000-0000 --info --target-itl
Data collected at : Wed, 23 Feb 2022 23:10:15 -0000
B: Bytes, s: Seconds, Avg: Average, Acc: Accumulative,
ns: Nano Seconds, ms: Milli Seconds, us: Micro Seconds,
GB: Giga Bytes, MB: Mega Bytes, KB: Killo Bytes,
ECT: Exchange Completion Time, DAL: Data Access Latency

Interface : fc1/22
+-----+-----+-----+-----+-----+
| Metric | Min | Max | Avg |
+-----+-----+-----+-----+-----+
| Read IOPS (4sec Avg) | NA | NA | 0 |
| Write IOPS (4sec Avg) | NA | NA | 0 |
| Read Throughput (4sec Avg) | NA | NA | 0 |
| Write Throughput (4sec Avg) | NA | NA | 0 |
| Read Size (Acc Avg) | 512 B | 1048576 B | 43544 B |
| Write Size (Acc Avg) | 512 B | 1048576 B | 23138 B |
| Read DAL (Acc Avg) | 23.0 us | 30.0 ms | 3.2 ms |
| Write DAL (Acc Avg) | 22.0 us | 30.0 ms | 70.2 us |
| Read ECT (Acc Avg) | 23.0 us | 275.9 ms | 4.2 ms |
| Write ECT (Acc Avg) | 87.0 us | 249.8 ms | 442.7 us |
| Write Host Delay (Acc Avg) | 0 ns | 0 ns | 0 ns |
| Write Array Delay (Acc Avg) | NA | 0 ns | 0 ns |
| Write IO Seq count (Acc Avg) | 0 | 0 | 0 |
+-----+-----+-----+-----+-----+
```

## Slowest and busiest switch ports in real-time

The slowest and busiest correlation is provided by the SAN Analytics feature. Exchange completion time (ECT) helps administrators understand which ports are the slowest in a fabric. Increased ECT values show performance degradation in the SAN fabric, especially if the backing storage system is using fast NVMe drive sets in conjunction with FC-NVMe.

Run the following command to gain insight into switch ports with the highest ECT.

```
showanalytics --top --key ECT
```



```
U34-C9132T-B# showanalytics --top --key ECT
```

Data collected at : Wed, 23 Feb 2022 23:28:04 -0000

PORT	VSAN	Initiator	Target	LUN	ECT	
					Read	Write
fc1/29	102	0x190043	0x1901c0	0025-0000-0000-0000	1.0 ms	291.0 us
fc1/29	102	0x190044	0x1901c0	0021-0000-0000-0000	202.0 us	746.0 us
fc1/22	102	0x190042	0x190160	0013-0000-0000-0000	0 ns	805.0 us
fc1/22	102	0x190041	0x190160	0013-0000-0000-0000	0 ns	401.0 us
fc1/21	102	0x190042	0x190180	0000-0000-0000-0000	99.0 us	249.0 us
fc1/22	102	0x190042	0x190160	0000-0000-0000-0000	85.0 us	257.0 us
fc1/22	102	0x190041	0x190160	0000-0000-0000-0000	96.0 us	238.0 us
fc1/21	102	0x190046	0x190180	0002-0000-0000-0000	91.0 us	239.0 us
fc1/28	102	0x190041	0x1900c1	001c-0000-0000-0000	99.0 us	215.0 us
fc1/21	102	0x190043	0x190180	0013-0000-0000-0000	0 ns	312.0 us

This output provides granularity in the form of milliseconds (ms), microseconds (us), and nanoseconds (ns).

## Cisco Nexus Dashboard Fabric Controller

This section describes Cisco Nexus Dashboard Fabric Controller (NDFC) capabilities.

### Tx and Rx detection

From NDFC, administrators can view the performance utilization of ports. Administrators can select the arrow icon next specific ports and view a historical diagram on the performance of these ports.

Use the following procedure to view the Rx and Tx utilization for the port channel supporting Fabric B.

To access the vantage point, perform the following steps:

#### Procedure

1. Select **Fabrics** from the navigation tree.
2. Click on the fabric that is experiencing congestion.

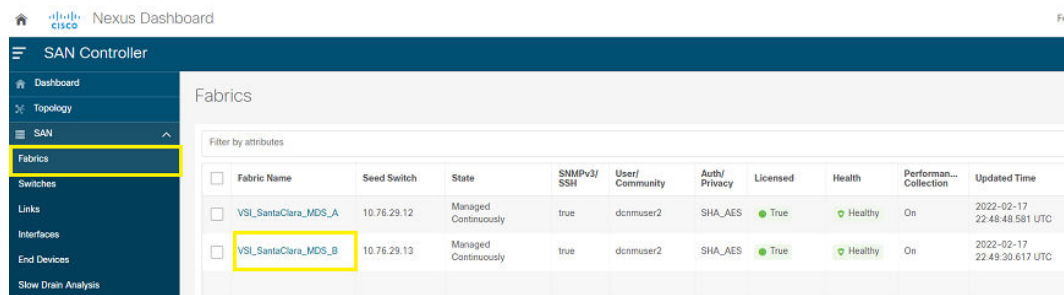

3. In the fabric pop-up window, select the highlighted arrow.

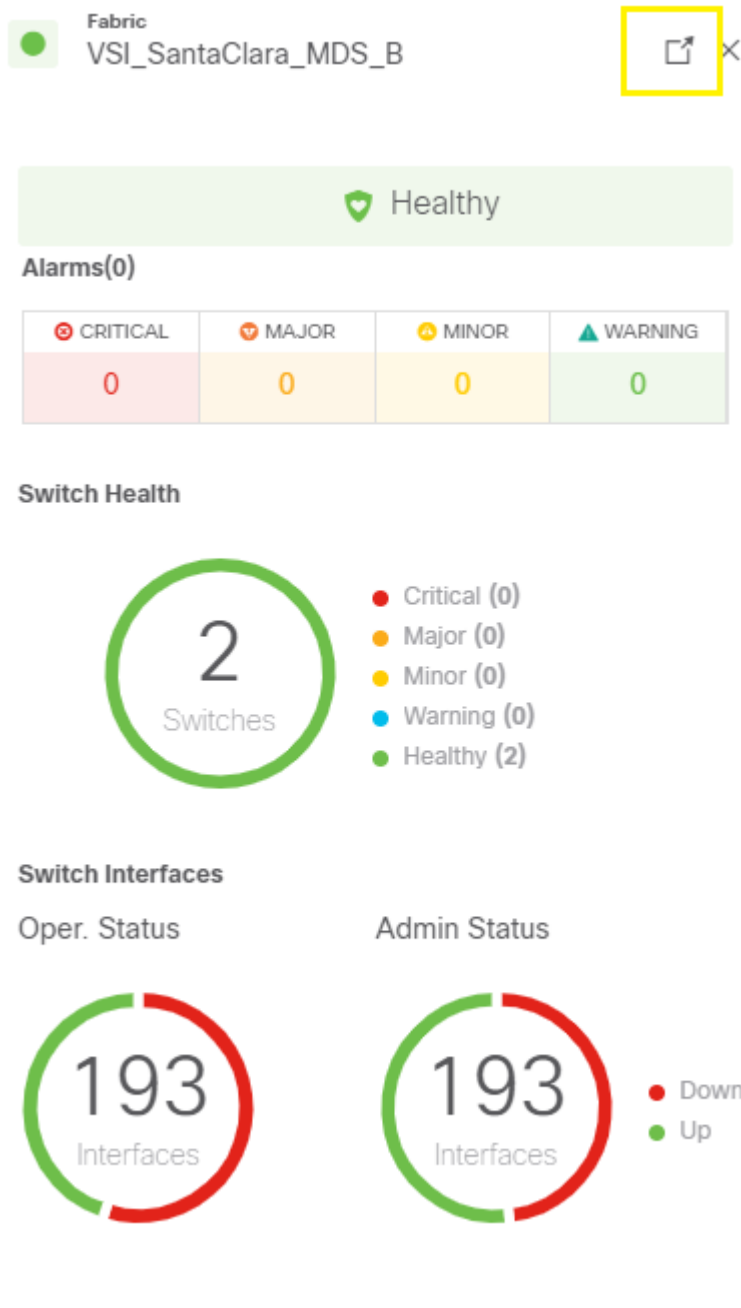

4. Select **Interfaces** from the menu.
5. Apply filters to list the suspected port.
6. Select the arrow icon next to a specific port based on the performance graph.

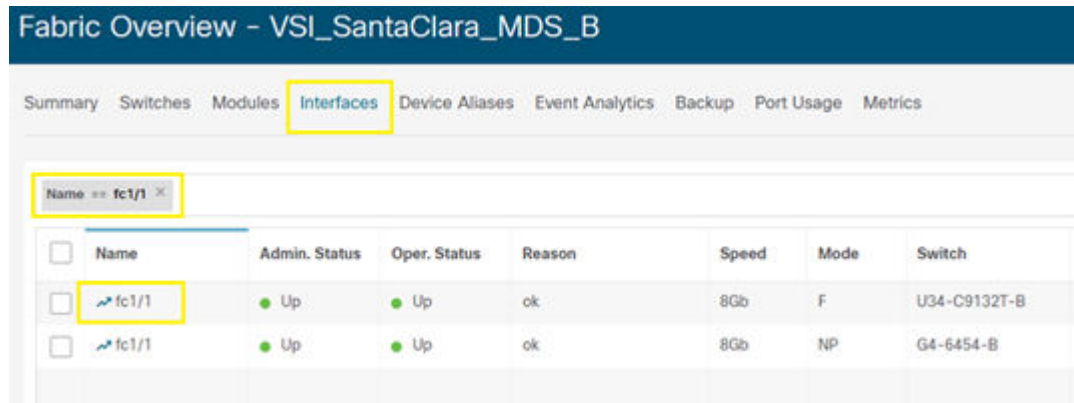

You will be presented with a performance graph showing Tx and Rx utilization.

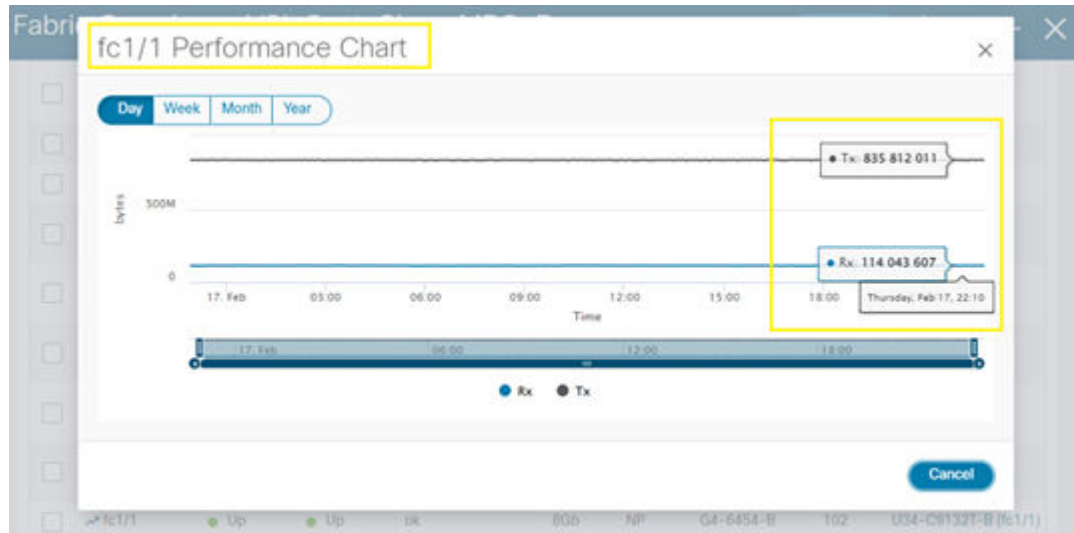

## RxB2Bto0 counters

Additionally, administrators can view native Cisco MDS counters from NDFC to provide insight into port congestion. Administrators must enable slow drain analysis on the fabrics to use this feature. Slow drain analysis must run 24/7 on each fabric.

To view RxB2Bto0 counters, perform the following steps:

### Procedure

1. Select **Slow Drain Analysis** from the navigation tree.
2. Select the fabric suspected of congestion.



The screenshot shows the Cisco Nexus Dashboard SAN Controller interface. The left navigation pane is expanded to 'Slow Drain Analysis'. The main content area is titled 'Slow Drain Analysis' and includes a 'Collection Configuration' section. The 'Fabric' dropdown is set to 'VSI\_SantaClara\_MDS\_A' and the 'Duration' dropdown is set to 'Once'. Below these, there are radio buttons for '10 minutes', '30 minutes', '1 Hour', and 'Custom', with a '2' in a text box followed by 'Hours'. Below the configuration is a table titled 'All Slow Drain Analysis Snapshots' with a filter 'Fabric contains B'. The table has columns for 'Fabric', 'Status', 'Start', and 'End'. One row is highlighted with a yellow box, showing 'VSI\_SantaClara\_MDS\_B' with a status of 'Collection In Progress', starting on 2/17/2022 at 3:09:00 PM and ending on 2/18/2022 at 3:08:00 PM.

The following figure shows a representation of Fibre Channel ports along with the counters. In this example, RxB2Bto0 has a high value indicating ingress congestion on ports FC1/19 and FC 1/20.

VSI\_SantaClara\_MDS\_B Details

Device Interfaces Show All Rows  Only Rows With Data

Filter by attributes

Switch Name	Interface	Speed	Connect To	Type	Level 3			Level 2		Level 1		TxWait[s...]	TxWait %	
					TxCredit...	RxLinkR...	TxLinkRe...	TxTimeo...	TxDiscard	TxWAvg...	RxB2Bto0			TxB2Bto0
U34-C9132T-B	fc1/19	32Gb	VSP5600H-40016-CL3-B	Storage	0	0	0	0	0	0	41866534	158	0.00	0.0000
U24-C9132T-B	fc1/20	32Gb	VSP5600H-40016-CL4-B	Storage	0	0	0	0	0	0	41855322	213	0.00	0.0000
U34-C9132T-	fc1/29	32Gb	VSP5600H-40016-	Storage	0	0	0	0	0	0	100	0	0.00	0.0000

## Port Monitor logging

After you apply port monitoring polices to the fabric, you can natively view logs from NDFC. The following example shows that port fc 1/1 has set off a port alarm because of a high Tx data rate.

To view logs, perform the following steps:

### Procedure

1. From the navigation tree expand **Operations**, and then select **Event Analytics**.
2. Click **Events**.
3. Filter based on the fabric.
4. View the logs.

Group	Switch	Severity	Facility	Type	Count	Creation Time	Last Seen	Description	Ack
VSI_SantaClara_MDS_B	U34-C9132T-B	Info	DCNM	Port Up	12	2022/02/15-22:03:59	2022/02/17-22:44:21	Port fc1/30-320b is up	
VSI_SantaClara_MDS_B	U34-C9132T-B	Warning	DCNM	Port Down	6	2022/02/15-22:03:58	2022/02/17-22:44:20	Port fc1/30-320b (with end device: VSP5600H-4801B-CL4-A) in 16X4/8/16/32G FC Sup + 16X32G FC LEM in Slot 1: N/A	
VSI_SantaClara_MDS_B	U34-C9132T-B	Error	LICMGR	LOG_SMART	2	2022/02/16-19:26:20	2022/02/17-19:20:20	[pid=4360] Communications failure with the Cisco Smart License Utility (CSLU) : Could not resolve host sdx-local	
VSI_SantaClara_MDS_B	U34-C9132T-B	Error	LICMGR	LOG_SMART	1	2022/02/16-22:34:06	2022/02/16-22:34:06	[pid=4360] Communications failure with the Cisco Smart License Utility (CSLU) : Communications failure	
VSI_SantaClara_MDS_B	U34-C9132T-B	Warning	DCNM	Port Alarm	1	2022/02/16-18:39:41	2022/02/16-18:39:41	Other: Port: fc1/1, Reason: Tx Bytes 51099958825 => 51099990000B	
VSI_SantaClara_MDS_B	U34-C9132T-B	Warning	DCNM	Port Down	19	2022/02/07-23:28:56	2022/02/14-22:29:16	Port fc1/2 G4-6454-B 1/2 8Gb in 16X4/8/16/32G FC Sup + 16X32G FC LEM in Slot 1: N/A	
VSI_SantaClara_MDS_B	U34-C9132T-B	Warning	DCNM	Port Down	21	2022/02/07-23:29:15	2022/02/14-22:29:11	Port fc1/2 G4-6454-B 1/2 8Gb in 16X4/8/16/32G FC Sup + 16X32G FC LEM in Slot 1: N/A	
VSI_SantaClara_MDS_B	U34-C9132T-B	Warning	DCNM	Port Down	23	2022/02/07-23:29:15	2022/02/14-22:29:05	Port fc1/4 G4-6454-B 1/4 8Gb in 16X4/8/16/32G FC Sup + 16X32G FC LEM in Slot 1: N/A	
VSI_SantaClara_MDS_B	U34-C9132T-B	Info	DCNM	Port Up	8	2022/02/07-23:27:17	2022/02/14-22:02:19	Port fc1/2 G4-6454-B 1/2 32Gb is up	

## Cisco Nexus Dashboard Fabric Controller

Cisco Nexus Dashboard Fabric Controller (NDFC) provides real time insight into the top 10 busiest and slowest host systems. Select the attribute drop-down on the respective dashboard to view details about storage systems backing the fabric IOPs, throughput, and ECT. To enable this dashboard, SAN Insights (Cisco SAN Analytics) must be configured on the fabric for data collection to occur.

To access the NDFC dashboard, perform the following steps:

### Procedure

1. From the navigation tree, select **Dashboard**.
2. Click **SAN Insights**.
3. Select a protocol.

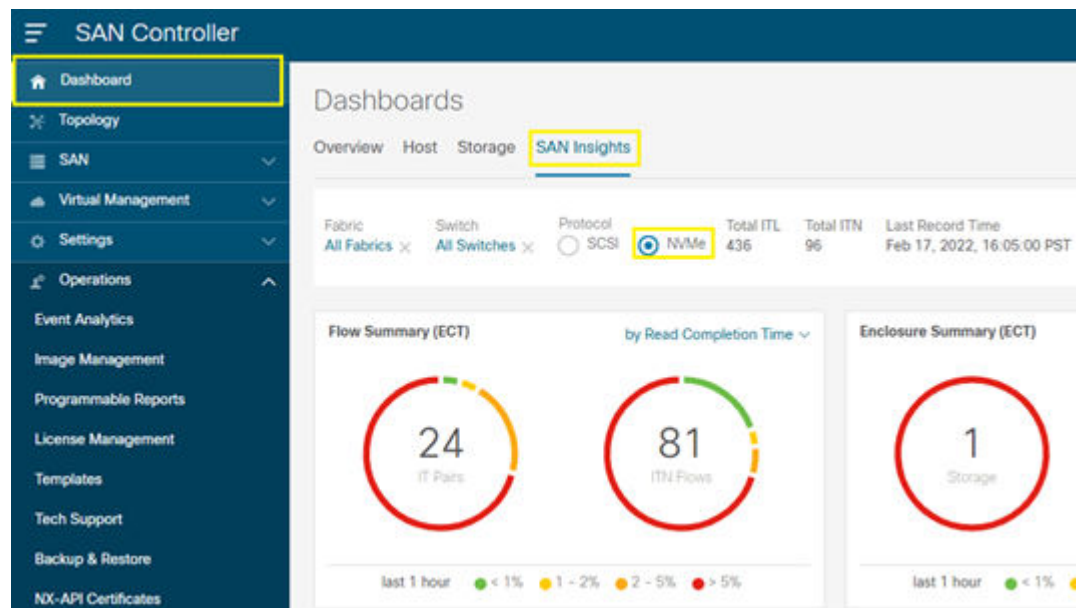

You will be presented with multiple dashboards that provide insight into the top 10 busiest hosts and storage systems within the fabric.

4. Select other metrics such as IOPs, throughput, or ECT from the <name of the menu> menu.

The following example shows two NVMe hosts with the highest utilization within the environment that helps identify the root cause of congestion caused by overutilization.

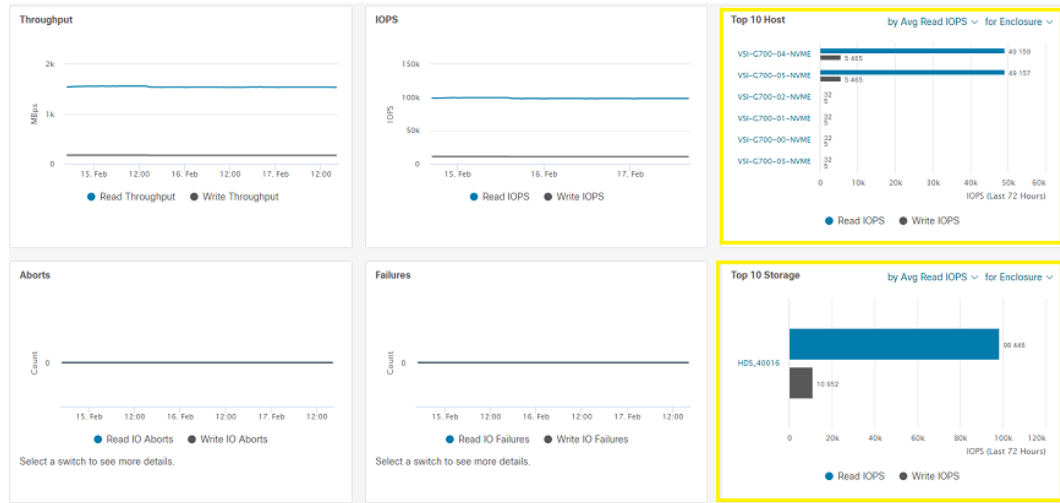

## Visibility into UCS Blade, vNIC, and vHBA traffic

After a fabric has been discovered with UCSM credentials and SAN Insights has been enabled on the fabric, you can select the primary fabric interconnect and gain performance and configuration insight into vHBAs, vNIC, and blade performance from NDFC.

To gain insight into these resources, perform the following steps:

### Procedure

1. From the navigation tree, select **Switches**.
2. Select the primary Fabric Interconnect.
3. In the Fabric window, select the highlighted arrow.

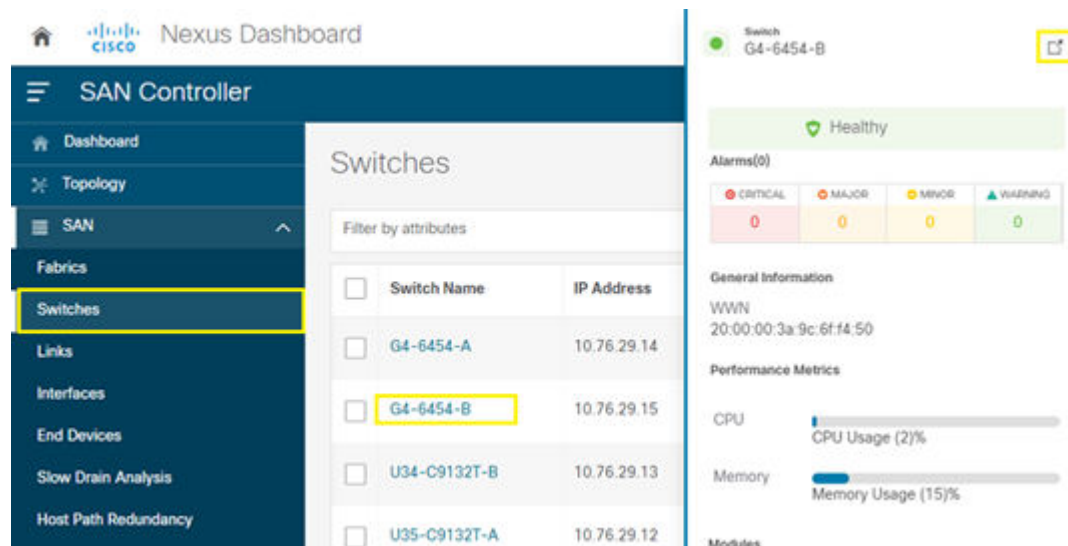

When selecting the primary Fabric Interconnect, you will see tabs at the top of the screen for Blades, vNIC, and vHBA. vHBA is selected in the following example.

DN	vHBA Name	WWPN	RX			TX		
			Min	Avg	Max	Min	Avg	Max
sys/chassis-1/blade-8/adaptor-1/host-fc-4	NVMe_B	20:00:00:25:85:85:08:06	25235574100	25252455765	25274757916	2943886448	2995734869	30433182
sys/chassis-1/blade-8/adaptor-1/host-fc-3	NVMe_A	20:00:00:25:85:85:0A:06	25164660152	25234051072	25309392668	2956121020	3002253653	30337407
sys/chassis-1/blade-7/adaptor-1/host-fc-4	NVMe_B	20:00:00:25:85:85:08:07	24993380104	25157388629	25289248792	2968212856	3013911957	30571760
sys/chassis-1/blade-7/adaptor-1/host-fc-3	NVMe_A	20:00:00:25:85:85:0A:07	24933689720	25165452458	25403542196	2971340860	3014498346	30712651

## Multipath verification to identify the cause of overutilization

NDFC provides administrators insight into SAN performance based on pathing, which correlates host profiles to storage system ports. Cisco SAN Analytics must be enabled on the fabric to use this feature.

To view storage performance on each path and pinpoint the cause of overutilization, perform the following steps:

### Procedure

1. From the navigation tree, select **Dashboard**.
2. Click **SAN Insights**.
3. Select **Monitor Metrics**.

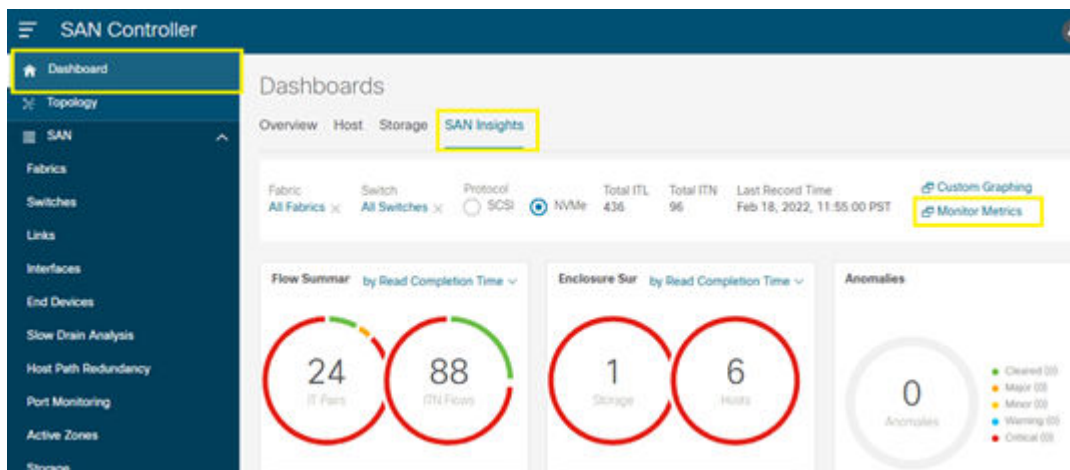

4. In the upper-left corner verify that **Viewing NVMe metrics** is visible. Select the appropriate vantage point based on host, storage, or pathing.

The following figure shows that hosts VSI-G700-04-NVME and VSI-G700-05-NVME have higher than average ECT, IOPs, and throughput, which indicates overutilization that stems from these hosts.

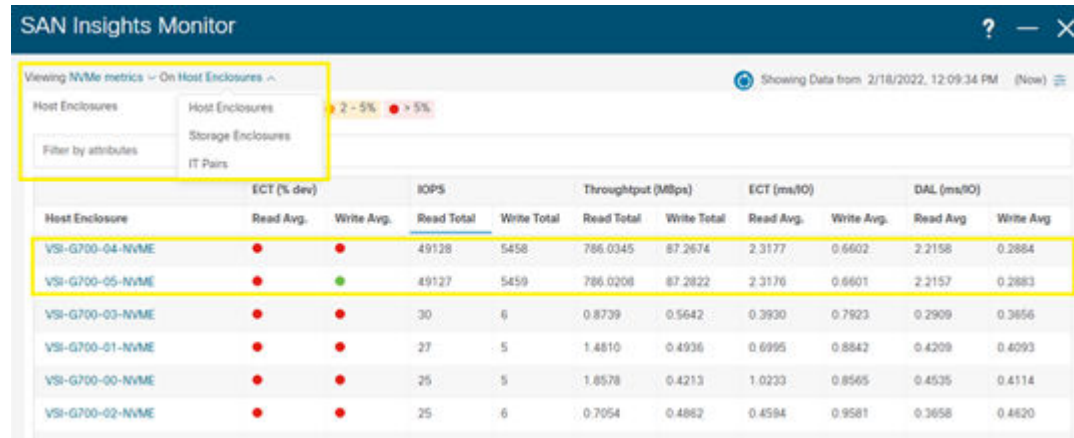

Alternatively, viewing the IT Pairs shows that Hitachi VSP ports CL3-B and CL4-B used by host VSI-G700-04 are showing higher than average utilization and ECT, which is the potential root cause of fabric congestion.

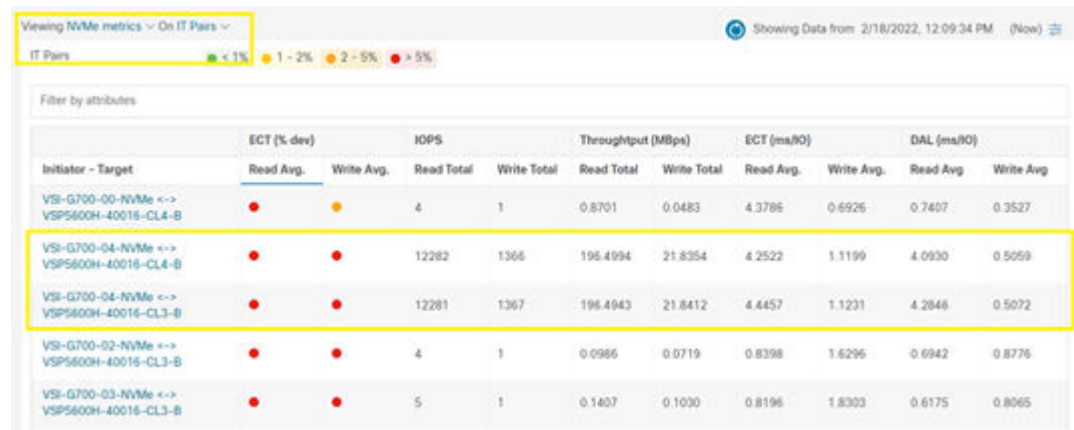

## Performance investigation of initiator, target, and LUN or namespace

SAN Insights (Cisco SAN Analytics) must be enabled to use this feature. From the NDFC dashboard, you can access detailed statistics of hosts that show high utilization. Viewing host information allows administrators to correlate VSP target ports to host initiator ports along with target LUNs. In the case of FC-NVMe, the respective namespace ID is shown.

The following is an example of performance investigation using SAN Analytics in conjunction with the NDFC dashboard to correlate initiator, target, and LUN or Namespace information.

### Procedure

1. From NDFC, select **Dashboard** from the navigation tree.
2. Select the **SAN Insights** tab.
3. Select NVMe for the protocol.

- From the top 10 hosts dashboard, select a host that shows high utilization to investigate. Metrics that can sort top 10 hosts include Read/Write IOPS, Read/Write Throughput, Read/Write ECT, and Read/Write DAL.

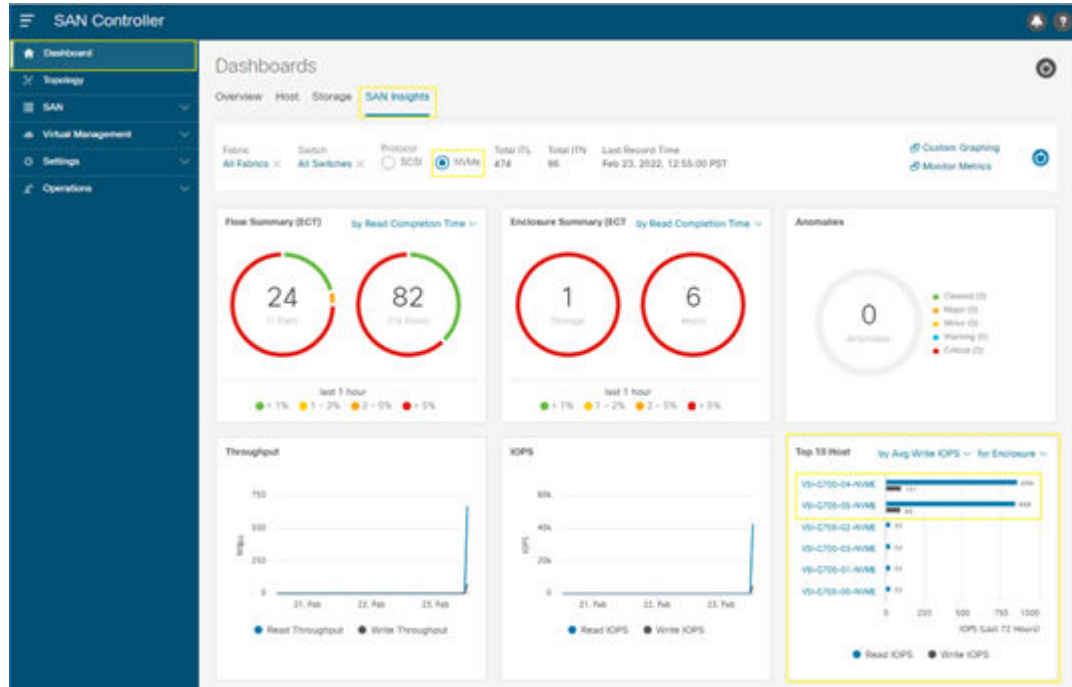

In this example, host VSI-G700-4-NVMe is selected, and its graph metrics page is presented. This provides insight to valuable metrics such as read and write, IOPS, throughput, ECT, DAL, and I/O.

- Select the **Table** tab to correlate the physical to virtual infrastructure as well as performance trends.

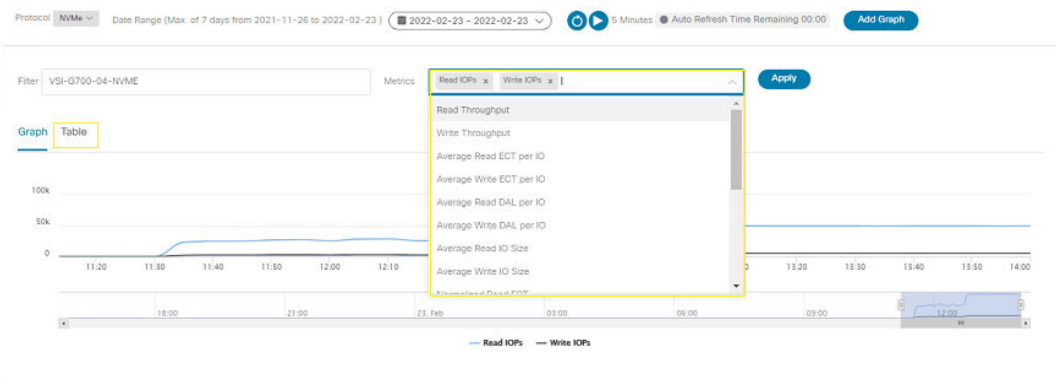

- From this vantage point, administrators can investigate host performance trends and correlate VSP target ports, NVMe namespace IDs, and Cisco MDS ports used in the SAN fabric on a per initiator basis. From the **Metrics** menu, administrators can modify the metrics.

The following example shows VSI-G700-04-NVME, which is using VSP 5600 storage port CL3-B. It is backed by namespace ID 4 and shows above average ECT per I/O compared to its respective counterparts, which indicates that there is performance degradation and further investigation is needed for these resources to pinpoint the cause of congestion within fabric B.



Filter: VSI-G700-04-NVME

Metrics: Read IOPs x Write IOPs x Average Read ECT per IO x   
 Select up to 4 metrics

Graph Table

Filter by attributes

Initiator Enc	Initiator	Target Enc	Target	Namespace ID	Switch IP Address	Port	Timestamp	Read IOPs	Write IOPs	Average Read ECT per IO (ms/IO)
VSI-G700-04-NVME	VSI-G700-04-NVMe	HDS_40016	VSP5600H-40016-CL1-B	1	10.76.29.12	fc1/19	2022-02-23 14:10:00	3086	342	0.2883
VSI-G700-04-NVME	VSI-G700-04-NVMe	HDS_40016	VSP5600H-40016-CL1-B	2	10.76.29.12	fc1/19	2022-02-23 14:10:00	3083	343	0.2769
VSI-G700-04-NVME	VSI-G700-04-NVMe	HDS_40016	VSP5600H-40016-CL1-B	3	10.76.29.12	fc1/19	2022-02-23 14:10:00	3084	344	0.2879
VSI-G700-04-NVME	VSI-G700-04-NVMe	HDS_40016	VSP5600H-40016-CL1-B	4	10.76.29.12	fc1/19	2022-02-23 14:10:00	3087	341	0.277
VSI-G700-04-NVME	VSI-G700-04-NVMe	HDS_40016	VSP5600H-40016-CL3-B	4	10.76.29.13	fc1/19	2022-02-23 14:05:00	3083	343	4.4121

5 Rows Page 1 of 20 << < 1-5 of 100 > >>

## Hitachi Ops Center Analyzer best practices

This section describes how to identify, troubleshoot, and resolve performance congestion using the Ops Center Analyzer.

### Ops Center Analyzer dashboard

Ops Center Analyzer dashboards are visual representations of the performance metrics of your infrastructure resources. The consolidated view helps administrators quickly interpret performance metrics and identify performance problems. The consolidated dashboard view allows for the unified management of the server, storage, and network infrastructure resources. You can ensure the health of your datacenter by proactively monitoring consumer groups, storage components, volumes, VMs, servers, and network devices.

Analyzer allows grouping of custom resources known as consumers so administrators can easily distinguish resources based on customer, region, or usage. The advanced visual analytics aid in visualizing the performance data in easy-to-use graphs and charts. These visual cues allow for intuitive performance management.

The following example shows an Analyzer dashboard indicating performance issues related to VMs and block-based storage LDEVs as well as a consumer resource.





## End-2-End (E2E) data analysis

Performance analysis starts with understanding whether any E2E data path resources are overloaded. By using E2E data analysis in Ops Center Analyzer, administrators can identify the root cause of performance degradation within VMs, hosts, SAN fabric, and VSP storage systems by viewing a visual representation of the end-to-end data path within the datacenter. From the E2E view, administrators are presented with easy to identify markers indicating exactly which resources are causing issues.

To access the E2E view from the dashboard, perform the following steps:

### Procedure

1. Log in to Hitachi Ops Center Analyzer.
2. From the dashboard, select the impacted resource based on consumer, VM/host, or volume.

In this example Platinum consumer is selected, and it shows that consumer resource Cisco UCS consumer has performance degradation because of exceeded VM and Volume thresholds.

3. Click **Show volume E2E View**.

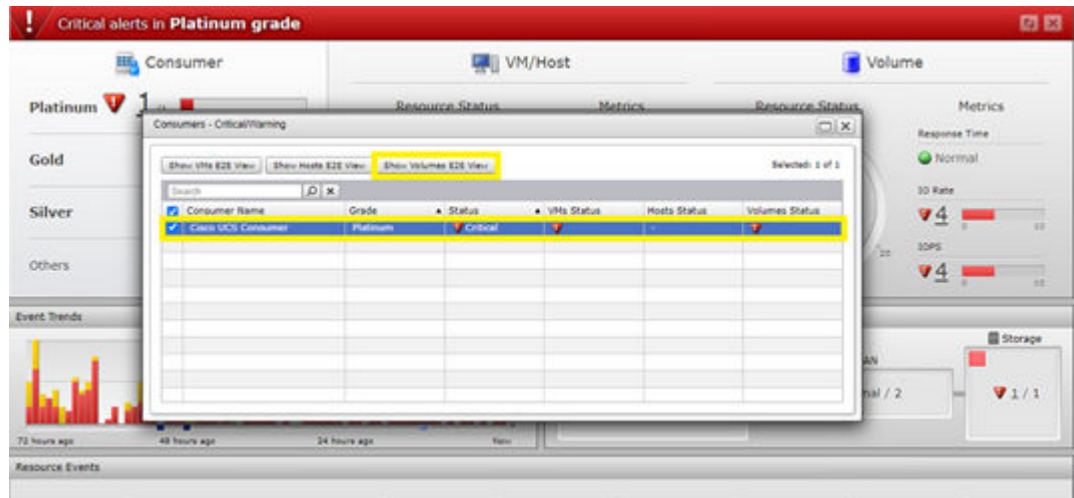

This vantage point shows the visual representation of VSP storage volumes and their association with the SAN fabric. LDEV IDs 0E, 0F, 10, and 11 have performance degradation alerts as well as the Cisco MDS 9132T SAN fabric switch that they use. The VSP storage resources that support these volumes such as ports, DKC processors, cache, VSP pools, and parity groups are also highlighted. This visual relation provides critical information for troubleshooting the SAN fabric with all end devices shown in correlation.

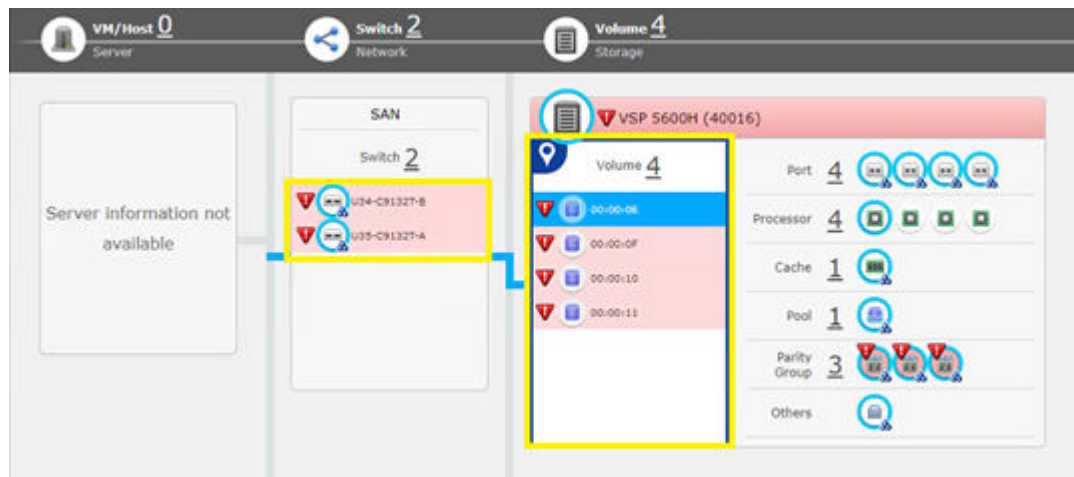

**Note:** Analyzer 10.8.1 does not visually associate VM/hosts to utilized NVMe resources; FC-SCSI resources will be available. FC-NVMe VM/host visualization will be included in future updates of Ops Center Analyzer. At the time of writing this paper, host association for FC-NVMe devices is a manual process from the **Show Details** view, which is covered in the following section.

## Show Detail view

Select a resource, right-click on the object, and then select **Show Detail** to view the resource performance summary report. The resource performance summary report opens in a new window.

In this example, to gain additional insight into storage configuration and performance, right-click on LDEV 0E and select Show Detail. LDEV 0E is an NVMe device using the FC-NVMe protocol. This best practice also applies to VMs, hosts, and SAN switches.

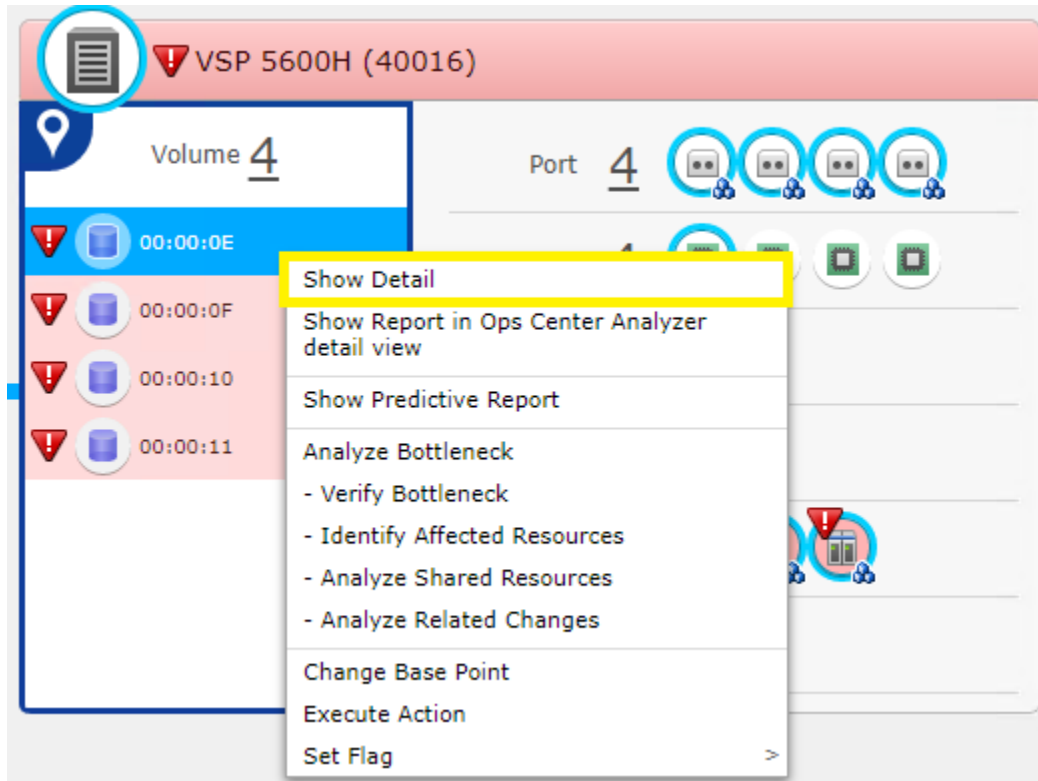

### Basic information

The following example shows information such as VSP Volume Label, NVM Subsystem ID/ Nickname, NVM Namespace ID, LDEV and capacity status. It also shows information about which end hosts use these NVMe resources from the NVM Host NQN. Additionally, from Show Detail, the Trend, Events, and Change History tabs provide additional information about the cause of performance degradation on the fabric.

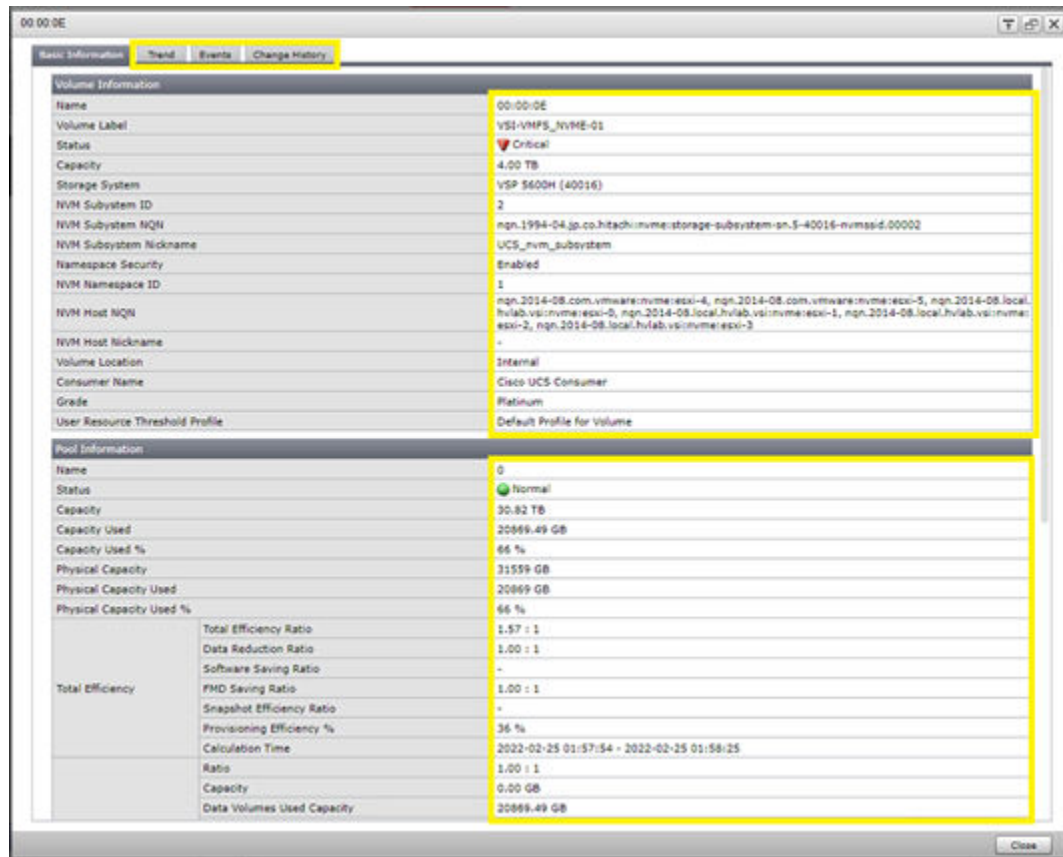

## Trend

Select the Trends tab to understand the critical performance degradation of an LDEV. Based on configured resource profiles, administrators can set static or dynamic thresholds to receive alerts after the resources pass the specified thresholds.

The following example shows that LDEV 0E has critical alerts for high IOPs and Transfer Rate utilization. Select the resource and Analyzer will provide a historical graph of the selected resource performance ranging from the last hour to the last 14 days.

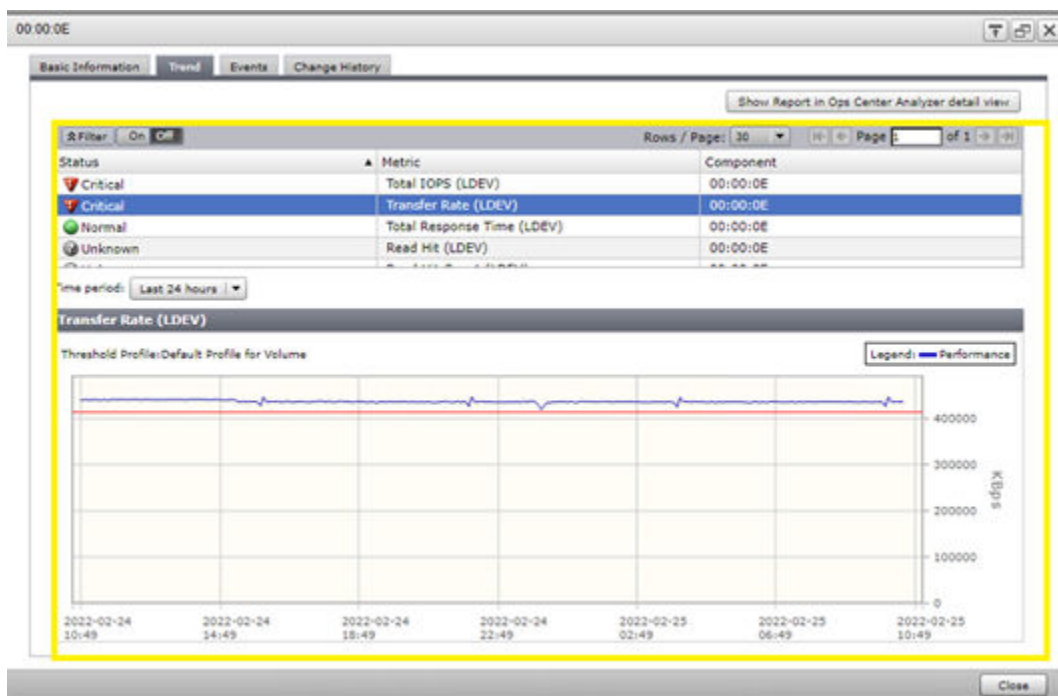

## Events

Select the Events tab to access a historical log of any performance events related to the selected resource.

Level	Message	Date Time	Category
Critical	"Transfer Rate (LDEV)" changed from Normal to Critical in "	2022-02-23 11:30:00	Performance
Critical	"Total IOPS (LDEV)" changed from Normal to Critical in "	2022-02-23 11:30:00	Performance
Information	"Transfer Rate (LDEV)" changed from Critical to Normal in "	2022-02-17 16:10:00	Performance
Information	"Total IOPS (LDEV)" changed from Critical to Normal in "	2022-02-17 16:10:00	Performance
Critical	"Total IOPS (LDEV)" changed from Normal to Critical in "	2022-02-17 16:05:00	Performance
Critical	"Transfer Rate (LDEV)" changed from Normal to Critical in "	2022-02-17 16:05:00	Performance

## Change History

The Change History tab provides a chronological timeline of any changes to resources including storage, SAN switches, VMs, and hosts. In this example, the Change History tab is selected on the supporting SAN switch, which shows that the firmware was upgraded on this resource recently.

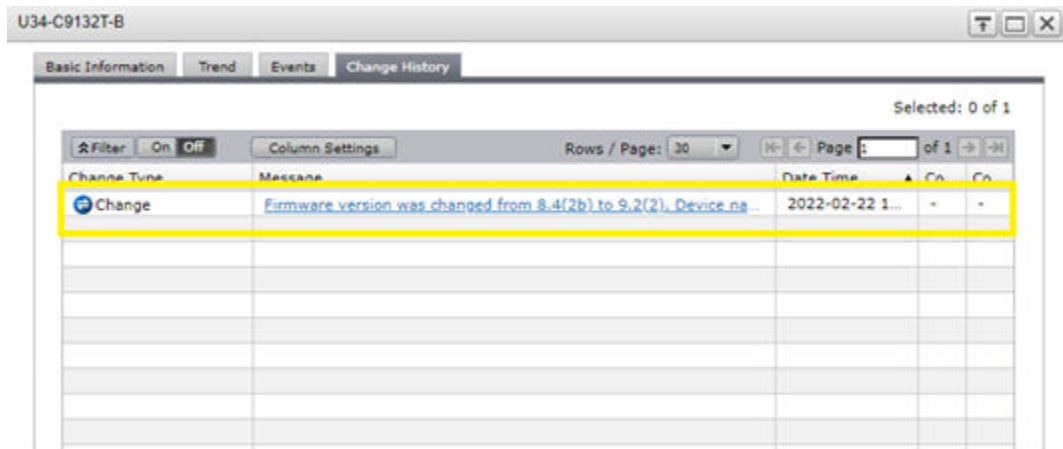

## Analyze Bottleneck

Ops Center Analyzer offers multiple troubleshooting tools for isolating a bottleneck candidate and identifying the root cause. Access the tools shown in the following figure for further analysis by right-clicking on an object and selecting Analyze Bottleneck.

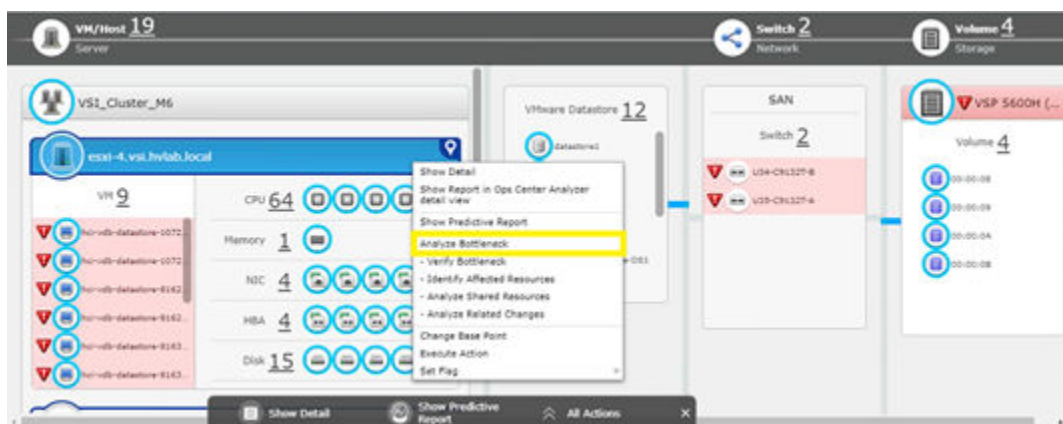

## Verify Bottleneck

Use Verify Bottleneck at the initial stage of analysis to compare performance charts of the base point of analysis with the bottlenecked candidate. The following example shows a VM with high VM CPU usage, which you can compare to the physical hypervisor. Administrators can change viewed metrics based on the selected resource from the Metric menu. In the following example, you can conclude that the VM selected shows above average utilization compared to the host.



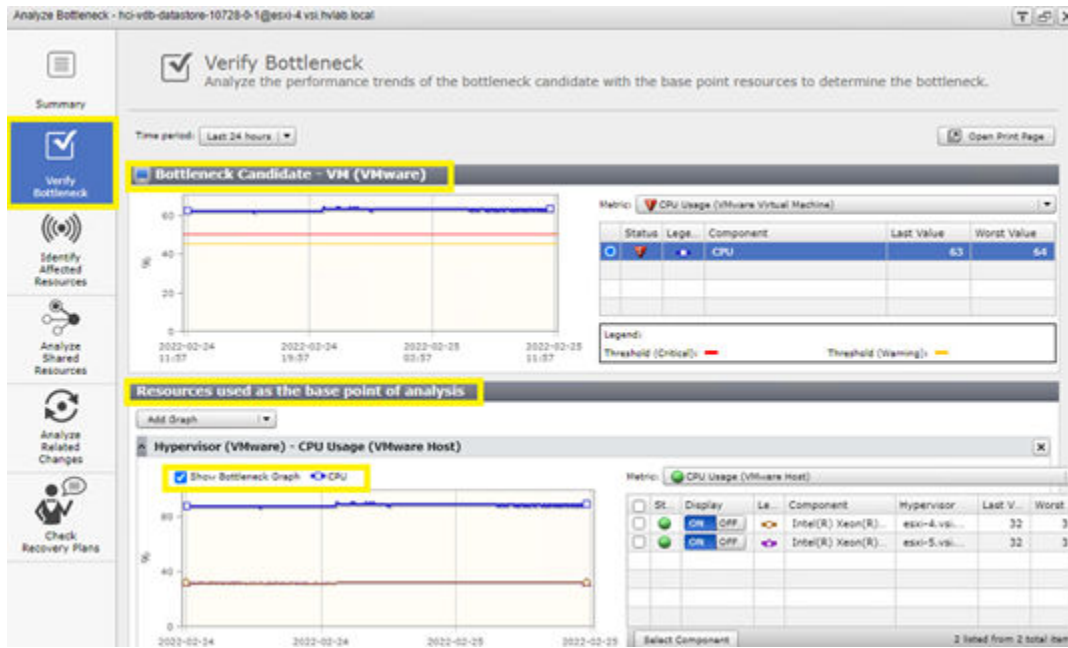

### Identify Affected Resources

Use Identify Affected Resources to display the user resources that rely on the bottlenecked resource. In the following example, the Cisco MDS 9132T SAN switch supporting fabric B is selected. Viewing Identify Affected Resources, shows that VSP NVMe LDEVs 0E, 0F, 10, and 11 rely on this Cisco MDS SAN switch.

**Identify Affected Resources**  
Identify the consumers, hosts, VMs, and volumes that use the bottleneck. You can also verify the status of each resource.

Consumers (1) VMs (0) Hosts (0) **Volumes (10)**

Name	Volume Label	Status	Consumer	Grade	Storage S.	NVM Host	Host Group
00:00:0E	VSI-VMFS_NVME-01	Critical	Cisco UCS Consumer	Platinum	VSP 560	-	-
00:00:0F	VSI-VMFS_NVME-02	Critical	Cisco UCS Consumer	Platinum	VSP 560	-	-
00:00:10	VSI-VMFS_NVME-03	Critical	Cisco UCS Consumer	Platinum	VSP 560	-	-
00:00:11	VSI-VMFS_NVME-04	Critical	Cisco UCS Consumer	Platinum	VSP 560	-	-
00:00:08	VSI-VMFS-01	Normal	#Unassigned Resources	-	VSP 560	-	VSI_56...
00:00:09	VSI-VMFS-02	Normal	#Unassigned Resources	-	VSP 560	-	VSI_56...
00:00:0A	VSI-VMFS-03	Normal	#Unassigned Resources	-	VSP 560	-	VSI_56...
00:00:0B	VSI-VMFS-04	Normal	#Unassigned Resources	-	VSP 560	-	VSI_56...



## Analyze Shared Resources

Use Analyze Shared Resources if you suspect that the root cause of the problem is resource contention, a noisy neighbor that disrupts the balance of resource usage. Compare performance charts of the bottleneck candidate to the resources using the bottleneck. After comparing performance across several resources with Analyze Shared Resources, isolate the actual bottleneck. In the following example, the hypervisor is selected as the bottleneck candidate, which you can compare to other VMs that use this candidate to see if there is performance degradation.

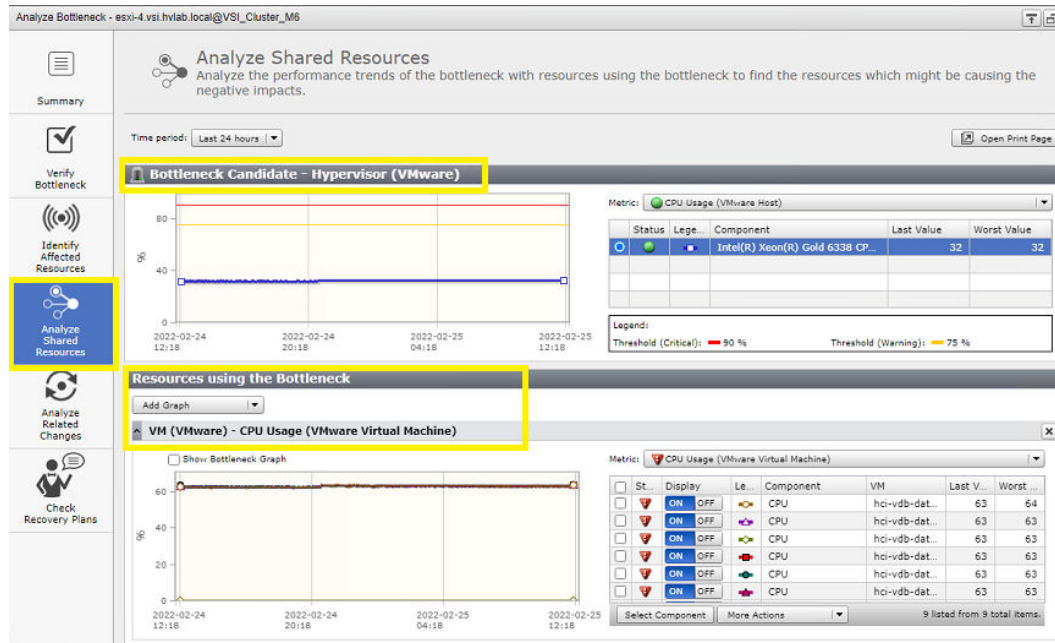

## Analyze Related Changes

Using Analyze Shared Resources does not reveal the actual bottleneck (noisy neighbor), or that the root cause of the problem is a recent configuration change. Use **Analyze Related Changes** to compare performance charts with configuration events. The bar graph portion of the chart represents the configuration changes made at a specific time. You can click on a bar to list the changes.

The screenshot displays the 'Analyze Related Changes' tool interface. At the top, it shows the title 'Analyze Related Changes' and a subtitle 'Analyze the configuration changes and correlate them with the performance data to determine if the configuration changes are the source of the bottleneck.' Below this, there are controls for 'Time period' (set to 'Last 14 days') and 'Resource Type' (set to 'All').

The main chart area is titled 'Bottleneck Candidate - Hypervisor (VMware)'. It features a bar graph on the left and a table on the right. The bar graph shows 'EVENTS' on the y-axis (0 to 10) and time on the x-axis (2022-02-11 to 2022-02-25). The table on the right is titled 'Metric: CPU Usage (VMware Host)' and has columns for 'Status', 'Leg...', 'Component', 'Last Value', and 'Worst Value'. The first row shows 'Intel(R) Xeon(R) Gold 6338 CP...' with a last value of 32 and a worst value of 37. A legend below the table indicates 'Threshold (Critical): 90%' and 'Threshold (Warning): 75%'.

Below the chart is a 'Change Histories' table for the period '2022-02-11 12:23 - [2022-02-25 12:23]'. The table has columns for 'Change Type', 'Device Name', 'Component Name', 'Attribute Type', 'New', 'Previous', 'Message', and 'Date Ti...'. The table lists several 'Add' operations for NVM Subsystem Ports and 'Change' operations for Firmware Versions.

Change Type	Device Name	Component Name	Attribute Type	New	Previous	Message	Date Ti...
Add	40016	CL1-C	-	-	-	NVM Subsystem Port was added to CL1-C	2022-...
Add	40016	CL3-C	-	-	-	NVM Subsystem Port was added to CL3-C	2022-...
Add	40016	CL2-B	-	-	-	NVM Subsystem Port was added to CL2-B	2022-...
Add	40016	CL2-C	-	-	-	NVM Subsystem Port was added to CL2-C	2022-...
Add	40016	CL3-B	-	-	-	NVM Subsystem Port was added to CL3-B	2022-...
Add	40016	CL4-B	-	-	-	NVM Subsystem Port was added to CL4-B	2022-...
Add	40016	CL1-B	-	-	-	NVM Subsystem Port was added to CL1-B	2022-...
Add	40016	CL4-C	-	-	-	NVM Subsystem Port was added to CL4-C	2022-...
Change	U34-C9132T-B	-	Firmware Version	9.2(2)	8.4(2b)	Firmware version was changed from 8.4...	2022-...
Change	U35-C9132T-A	-	Firmware Version	9.2(2)	8.4(2b)	Firmware version was changed from 8.4...	2022-...
Remove	40016	00:F6:A0	-	-	-	Volume was not recognized from 40016...	2022-...

## Sparkline View

Use the Sparkline View to analyze the health and performance of the resources in the datacenter monitoring environment. The Sparkline View displays performance reports for multiple nodes in the same pane for a quick comparison between different nodes. You can display detailed performance metrics for each node and find a correlation with other nodes. In the following example, a VSP 5600H is selected as the sparkline candidate, where you can compare VSP resources such as port, processor, cache, pool, and parity group performance in a single pane.

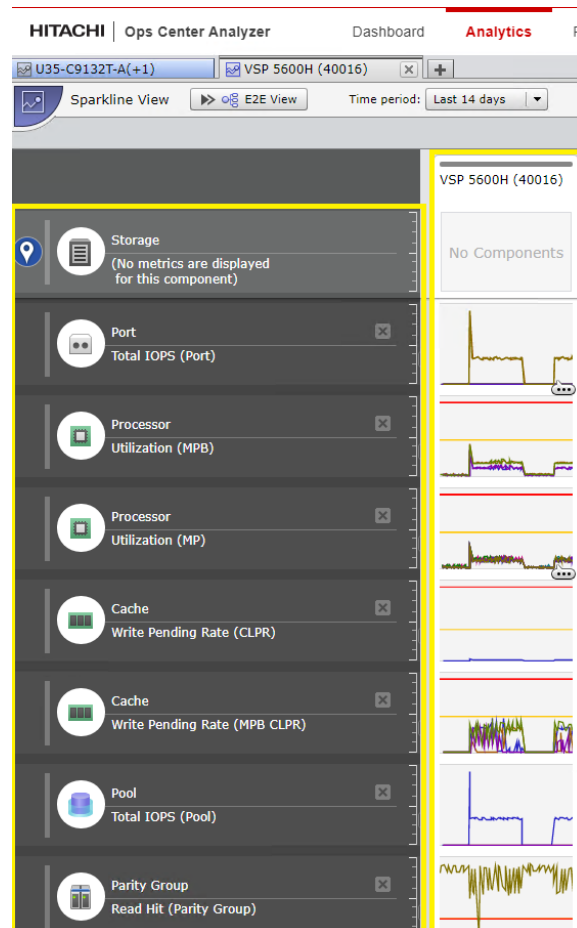

## Monitor settings

Define the monitoring conditions for detecting deterioration in the service performance of virtual machines and volumes using dynamic thresholds or static thresholds. You can create rules and conditions to automate resource assignment to monitoring profiles. Using these rules, the newly discovered user resources are automatically assigned to the user resource threshold profiles. When you do not create monitoring threshold profiles or define assignment rules, the newly discovered resources are automatically registered to the default threshold profiles.

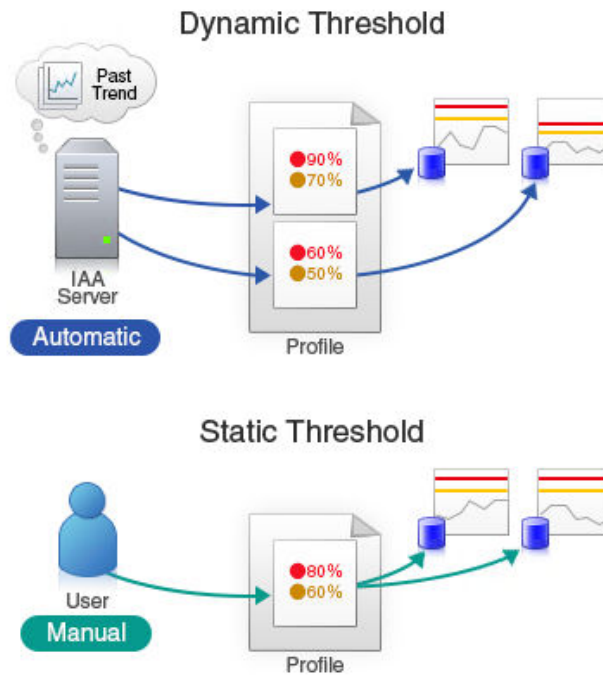

## Ops Center Analyzer notifications

Setting notifications is an easy way to stay informed on the status of infrastructure resources and events. Monitoring resources is both an active and passive activity for IT administrators. You can use Ops Center Analyzer to configure email notifications that provide detailed information about issues with resource management. If multiple administrators rely on the Ops Center Analyzer service, you can create different profiles to deliver different types of information based on the profile settings. In the following example profile, a notification alert provides critical, warning, and information alerts based on performance and event action categories.

**Create Notification Profile**

To create a notification profile, enter a profile name. Select the notification event level, the notification category, and the delivery address. If you do not see the email address you need, open [Add Email Address].

Profile Name: \* Notification Profile

Description:

Notification Event Level:
   
 Critical
   
 Critical, Warning
   
 Critical, Warning, Information

Notification Category:
   
 All
   
 Specify Categories

**Notification Categories**

Category	Selected
Category	<input type="checkbox"/>
Performance	<input checked="" type="checkbox"/>
Event Action	<input checked="" type="checkbox"/>
Management	<input type="checkbox"/>

Delivery Address:

**Email Addresses**

Email Address	Status	Description
<input checked="" type="checkbox"/> admin@admin.com	Active	-

Add Email Address

Email Recipient Type: \* TO

\* Required

OK Cancel

## Hitachi Ops Center Automator integration

Ops Center Analyzer supports integration with Ops Center Automator. This support provides direct access to the service templates in Ops Center Automator from the Execute Action window in the Ops Center Analyzer UI. When administrators notice a performance problem in a shared infrastructure, they can run the appropriate action or service template to resolve it. This allows administrators to have auto-remediation capabilities in the event of a degradation of performance or capacity.

View the following [video](#) for more information on Ops Center Analyzer integration with Ops Center Automator.

## Hitachi Ops Center detail view server

Ops Center Analyzer detail view server provides historical report analysis across the entire datacenter infrastructure, enabling creating advanced monitoring reports, and performing additional troubleshooting and diagnostics. Unlike the Analyzer server, the detail view server provides additional performance outside of the 14-day window. The following section describes the capabilities of the Analyzer detail view server for troubleshooting performance congestion. See the [Appendix \(on page 40\)](#) for a list of Cisco SAN performance metrics that can be collected from detail view server.

**Note:** You can access Analyzer detail view reports any time directly from the E2E view by clicking any resource icon and selecting Show Report in Analyzer detail view.

## Reports

After logging in to Ops Center Detail View Server, administrators are presented with the resource tree where resources can be selected to view the latest available default reports in the Performance view. From the resource tree, selections can be made based on Hypervisor, SAN switch, or VSP storage system.

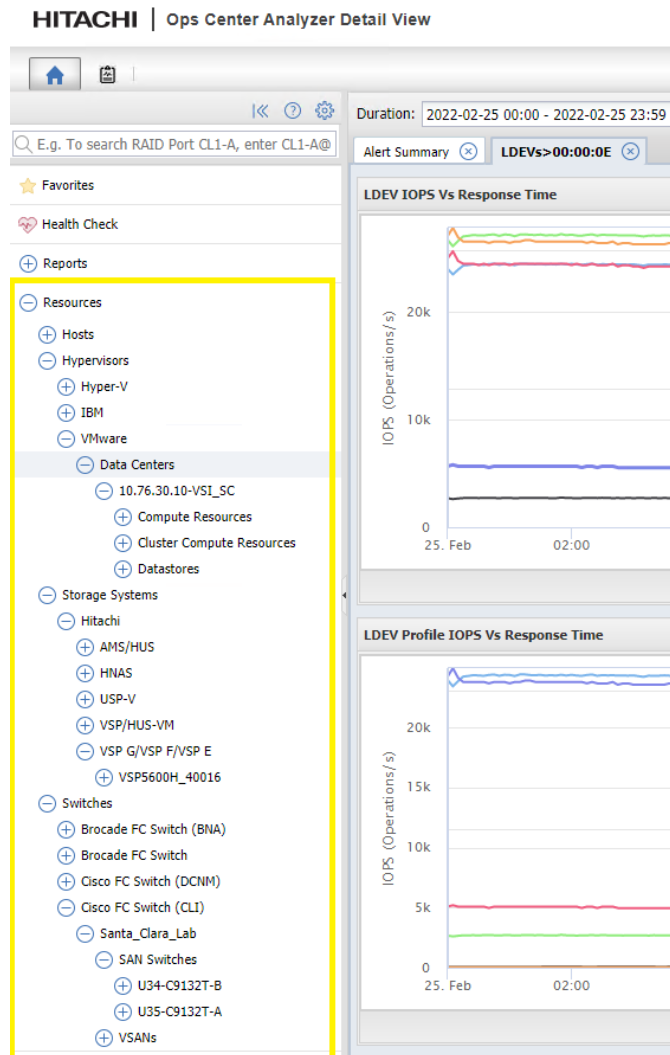

After a resource has been selected, administrators can extract reports in multiple formats including PNG, JPEG, PDF, SVG, and CSV from the 3 ellipses icon. Along with extracting reports, administrators can do performance comparisons using the Compare With function built into every report. The following example shows NVMe LDEV 0E IOPs performance monitored over two custom time durations. You can conclude that over this date range, resources that rely on this LDEV have been impacted by a configuration change or performance issue that is causing higher than normal LDEV response times.

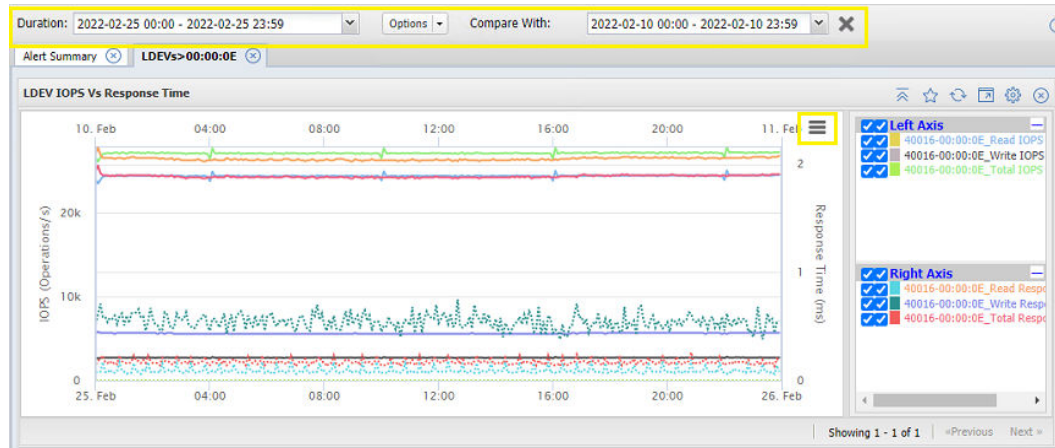

## Custom reports

From the Ops Center detail view server, administrators can create their own custom reports that might not originally be available from a selected resource. In this example, a custom report is created for the fabric B SAN switch that is under congestion conditions. From the detailed view server, select the report name, as well as X and Y axis values, which in this case is Cisco switch port RX B2B Credit Transitions to 0 and Port Channel Rx Utilization.



Viewing the custom report output, administrators can narrow down ports that are experiencing congestion conditions. Here we can see Fibre Channel ports fc1/19 and fc1/20 are showing extremely high RXB2Bto0 transitions. We can also understand that port-channel 12, which uses fc1/1 that supports host connectivity of these storage ports to our hosts, is showing extremely high utilization narrowing the source of congestion.

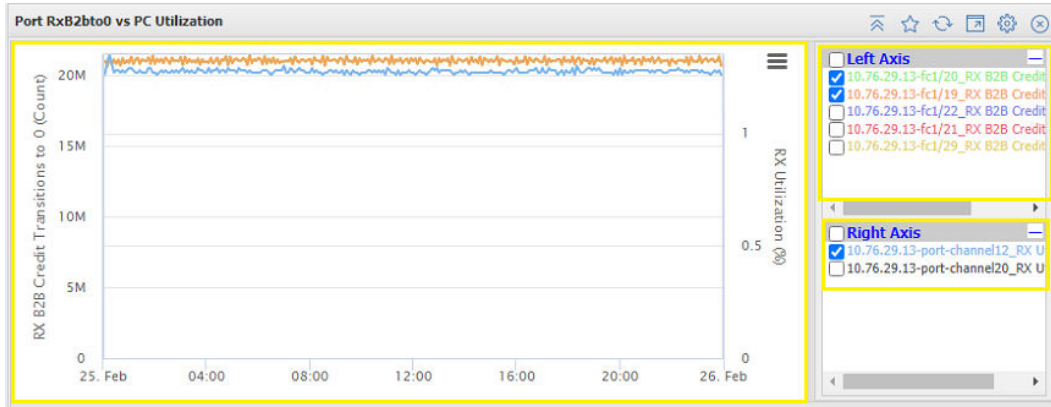

### Custom MQL reports for Cisco UCS

The Ops Center Analyzer detail view query language is a regex-based query language used to retrieve and filter data stored in the Analyzer detail view database. MQL allows complex analysis on this data in real-time with constant runtime. MQL syntax makes it possible to traverse relations, identify patterns in data, and provides a mechanism to establish correlations. Administrators can use the following queries in Ops Center Analyzer detail view server for Cisco UCS-based deployments.

Cisco Port and Hitachi storage port performance:

```
fabCiscoSwitchPort/*switchPort/*sp/raidPort[@totalIOPS rx b .*]
```

In this example, we can correlate VSP storage port performance for utilized Cisco host ports. We filtered based on Fabric B, and we can see that fc1/19 using VSP 5600H port CL3-B is showing high IOP utilization. This query can help narrow down performance issues from the VSP system perspective.

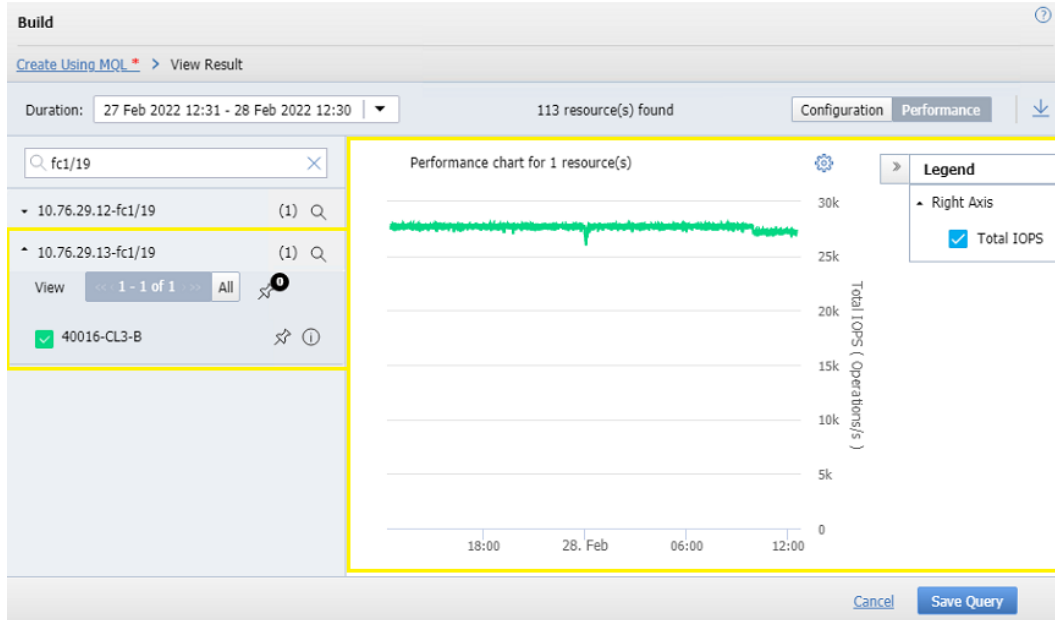

Cisco port channel and VMware host:

```
fabCiscoPortChannel/*portChannel/*hbaPort/*hba/*vmhba/h[@diskWrite rx b .*]
```

This example correlates VMware host performance per host vHBA to the Cisco Port Channel supporting the hosts. This query can be used to narrow down performance congestion on a Cisco UCS environment running VMware.



## Alerting

Ops Center Analyzer detail view classifies metrics into two types: configuration and performance. Configuration metrics change infrequently, and include resource status, capacity, while performance metrics include IOPS and response time.

Administrators can set various alert conditions for configuration and performance metrics. When these conditions are met, a notification can be sent by email, SNMP, or a Syslog server that aids in prevention and identification of performance degradation. In the following example, a custom alert for Cisco MDS 9132T, which supports fabric B under congestion conditions, specifies an alert to be shown when RxB2Bto0 credits on selected switch ports exceeds a limit of 2000.

The screenshot displays the 'Active Alerts' section of the Ops Center Analyzer. A table lists the alert details, and a detailed view is shown below.

Category	Alert Name	Severity	Updated At	Notification Status
Switches Cisco FC Switch (CLI)	RxB2B Alert	<span style="color: red;">!</span>	28 Feb 2022 13:53	Unsubscribed

**Alert Details**

Alert Name:	RxB2B Alert	Category:	Switches Cisco FC Switch ...	Resource:	Cisco Fabric Switch Port
Category:	Switches Cisco FC Switch (CLI)	Created On:	Cisco Fabric Switch Port	Name	Threshold (greater than)
Alert Condition:	RX B2B Credit Transitions to 0 is greater than 2000.0 for 1 samples out of 2 minutes	Monitoring Window:	From 12:00 AM to 11:59 PM	10.76.29.13-fc1/19	2000.0
Created By:	admin	Updated By:	NA	10.76.29.13-fc1/20	2000.0

[View Subscription Information](#)

## Appendix

This appendix lists the metrics that the Hitachi Ops Center Analyzer detail view server can collect from Cisco SAN switches onboarded using the CLI as the data collection method.

Attribute Name	Aggregation Operation	Unit	Data Granularity
CPU Utilization	Sum of user CPU and kernalCpu	%	5 Minutes
Memory Utilization	Divide memTotal by memUsed and then convert to %	%	5 Minutes
User CPU Utilization	Direct	%	5 Minutes
Kernal CPU Utilization	Direct	%	5 Minutes
Idle CPU Utilization	Direct	%	5 Minutes
Memory Total In GB	Convert KB to GB	GB/Sec	5 Minutes
Memory Used In GB	Convert KB to GB	GB/Sec	5 Minutes
TX Rate	Divide txBytes by 1024	KB/Sec	5 Minutes
RX Rate	Divide rxBytes by 1024	KB/Sec	5 Minutes
TX Utilization	Divide speed by txBytes and then convert to GB and then to %	%	5 Minutes
RX Utilization	Divide speed by rxBytes and then convert to GB and then to %	%	5 Minutes
Discarded Frames Count	Sum of rxDiscardCount and txDiscardCount	Number	5 Minutes
Invalid CRC Count	Direct	Number	5 Minutes
NOS Count	Sum of outputNOS and inputNOS	Number	5 Minutes
OLS Count	Sum of outputOLS and inputOLS	Number	5 Minutes
LRR Count	Sum of outputLRR and inputLRR	Number	5 Minutes
Port Error Count	Sum of rxErrorCount and txErrorCount	Number	5 Minutes

Attribute Name	Aggregation Operation	Unit	Data Granularity
Temperature	Direct	Centigrade	5 Minutes
Voltage	Direct	V	5 Minutes
Current	Direct	mA	5 Minutes
Optical Tx Power	Direct	dBm	5 Minutes
Optical Rx Power	Direct	dBm	5 Minutes
RX B2B Credit Transitions to 0	DELTA between previous and current data points	Count	5 Minutes
TX B2B Credit Transitions to 0	DELTA between previous and current data points	Count	5 Minutes
RX B2B Credit Remaining	Direct	Count	5 Minutes
TX B2B Credit Remaining	Direct	Count	5 Minutes
RX B2B Credit Total	Direct	Count	5 Minutes
TX B2B Credit Total	Direct	Count	5 Minutes
TX Rate	Divide txBytes by 1024	KB/Sec	5 Minutes
RX Rate	Divide rxBytes by 1024	KB/Sec	5 Minutes
TX Utilization	Divide speed by txBytes and then convert to GB and then to %	%	5 Minutes
RX Utilization	Divide speed by rxBytes and then convert to GB and then to %	%	5 Minutes

**Hitachi Vantara**

Corporate Headquarters  
2535 Augustine Drive  
Santa Clara, CA 95054 USA



[HitachiVantara.com/contact](https://HitachiVantara.com/contact)